

OEM Surplus Close Out of Refrigeration and Air Conditioning Compressors - Out of Manufacturers
Warranty - Limited Quantities - All compressors offered subject to prior sale.

R-410A / R-22 AIR CONDITIONING COMPRESSORS

COPELAND

Scroll Air Conditioning Compressors

R-410A 230/60HZ/1 PHASE



CAT#	MODEL	H.P.	BTU	Volts/Ph	Price Ea.
F13ZP14	ZP14K6E-PFV	1.25	14,000	230/60/1	\$325.00
F13ZP16	ZP16K5E-PFV	1.5	16,000	230/60/1	\$350.00
F13ZP20	ZP20K5E-PFV	1.75	20,000	230/60/1	\$395.00
F13ZP21	ZP21K5E-PFV	2	21,000	230/60/1	\$415.00
F13ZP24	ZP24K5E-PFV	2	24,000	230/60/1	\$425.00
F13ZP25	ZP25K5E-PFV	2	25,000	230/60/1	\$425.00
F13ZP26	ZP26K3E-PFV	2.25	26,000	230/60/1	\$450.00
F13ZP29	ZP29K5E-PFV	2.25	29,000	230/60/1	\$495.00
F13ZP31	ZP31K5E-PFV	2.5	31,000	230/60/1	\$495.00
F13ZP32	ZP32K3E-PFV	2.5	32,000	230/60/1	\$495.00
F13ZP34	ZP34K5E-PFV	3	34,000	230/60/1	\$525.00
F13ZP36	ZP36K5E-PFV	3	36,000	230/60/1	\$525.00
F13ZP38	ZP38K5E-PFV	3	38,000	230/60/1	\$550.00
F13ZP39	ZP39K5E-PFV	3.25	39,000	230/60/1	\$550.00
F13ZP42	ZP42K5E-PFV	3.5	42,000	230/60/1	\$575.00
F13ZP44	ZP44K5E-PFV	3.75	44,000	230/60/1	\$595.00
F13ZP51	ZP51K5E-PFV	4.5	51,000	230/60/1	\$695.00
F13ZP54	ZP54K5E-PFV	4.5	54,000	230/60/1	\$695.00

COPELAND Scroll Air Conditioning Compressors

R-410A 460/60HZ/3 PHASE

CAT#	MODEL	H.P.	BTU	Volts/Ph	Price Ea.
F13ZP29D	ZP29K5E-TFD	2.25	29,000	460/60/3	\$495.00
F13ZP31D	ZP31K5E-TFD	2.5	31,000	460/60/3	\$495.00
F13ZP36D	ZP36K5E-TFD	3	36,000	460/60/3	\$525.00
F13ZP42D	ZP42K5E-TFD	3.5	42,000	460/60/3	\$575.00
F13ZP49D	ZP49K5E-TFD	4	49,000	460/60/3	\$650.00
F13ZP51D	ZP51K5E-TFD	4.5	51,000	460/60/3	\$675.00

COPELAND Two-Stage Scroll Air Conditioning Compressors

R-410A 230/60HZ/1 PHASE

CAT#	MODEL	H.P.	BTU	Volts/Ph	Price Ea.
F13ZPS20	ZPS20K5E-PFV	2.25	20,000	230/60/1	\$395.00
F13ZSP21	ZPS21K5E-PFV	2.5	21,000	230/60/1	\$425.00
F13ZPS30	ZPS30K5E-PFV	3	30,000	230/60/1	\$495.00
F13ZPS40	ZPS40K5E-PFV	3.5	40,000	230/60/1	\$575.00
F13ZPS49	ZPS49K5E-PFV	4	49,000	230/60/1	\$750.00
F13ZPS51	ZPS51K5E-PFV	4.5	51,000	230/60/1	\$750.00

COPELAND Scroll Air Conditioning Compressors

R-22 460/60HZ/3 PHASE *WITH SPUD-ROTO LOCK VALVES EXTRA \$250.00

CAT#	MODEL	H.P.	BTU	Volts/Ph	Price Ea.
F11322D	ZR32KA-TFD	2.5	32,000	460/60/3	\$450.00
F11422D	ZR42K3-TFD	3.5	42,000	460/60/3	\$525.00
F11442D	ZR44KA-TFD	3.75	44,000	460/60/3	\$550.00
*A1C1442D	ZR144KCE-TFD	12	144,000	460/60/3	\$1495.00

BRISTOL 2 STAGE R-410A A/C COMPRESSORS

CAT#	MODEL	H.P.	BTU	Volts/Ph	Price Ea.
F13T81119	T81J195CBCA	1.75	19,000	230/60/1	\$450.00
F13T89A51	T89A515BBCA	4.5	51,000	230/60/1	\$695.00

COPELAND

Scroll Air Conditioning Compressors

R-410A 230/60HZ/3 PHASE



CAT#	MODEL	H.P.	BTU	Volts/Ph	Price Ea.
F13ZP243	ZP24K5E-TF5	2	24,000	230/60/3	\$425.00
F13ZP253	ZP25K5E-TF5	2	25,000	230/60/3	\$425.00
F13ZP383	ZP38K5E-TF5	3	38,000	230/60/3	\$550.00
F13ZP393	ZP39K5E-TF5	3	39,000	230/60/3	\$550.00
F13ZP423	ZP42K5E-TF5	3.5	42,000	230/60/3	\$575.00
F13ZP513	ZP51K5E-TF5	4.5	51,000	230/60/3	\$675.00

LG SCROLL AIR CONDITIONING COMPRESSORS

R-410A 230/60HZ/1 PHASE

CAT#	MODEL	H.P.	BTU	Volts/Ph	Price Ea.
F13029K1	APA029KAB	2.5	29,000	230/60/1	\$385.00
F13030K1	APA030KAA	2.5	30,000	230/60/1	\$385.00
F13031K1	APG031KAC	2.5	31,000	230/60/1	\$425.00
F13038K1	AQA038KAA	3.25	38,000	230/60/1	\$450.00
F13040K1	AQA039KAA	3.25	39,000	230/60/1	\$450.00
F13040K1	AQA040KAA	3.25	40,000	230/60/1	\$475.00
F13042K1	AQA042KAB	3.5	42,000	230/60/1	\$495.00
F13049K1	ABG049KAA	4	49,000	230/60/1	\$650.00
F13051K1	ABG051KAC	4.25	51,000	230/60/1	\$695.00

LG SCROLL AIR CONDITIONING COMPRESSORS

R-22 230/60HZ/1 PHASE

CAT#	MODEL	H.P.	BTU	Volts/Ph	Price Ea.
F13022SQ	SQA022KAC	2	22,000	230/60/1	\$395.00
F13026SQ	SQA026KAC	2.25	26,000	230/60/1	\$425.00
F13032SQ	SQA032KAC	2.5	32,000	230/60/1	\$450.00
F13038SQ	SQA038KAC	3.25	38,000	230/60/1	\$595.00
F13HAR	COPELAND-LG WIRING HARNESS				\$30.00

SAMSUNG ROTARY COMPRESSORS FOR A/C, HEAT PUMPS AND MINI-SPLIT SYSTEMS R-410A

CAT#	MODEL	H.P.	BTU	Volts/Ph	Price Ea.
A2C200	UG5C200INXJ2	1.75	20,000	208-230/60/1	\$350.00
A2C250	UG5C250INZJ2	2	25,000	208-230/60/1	\$395.00
A2C290	UG5A290INZJ2	2.5	29,000	208-230/60/1	\$295.00
A2C320	UG5T320IUZF2	2.5	32,000	208-230/60/1	\$495.00

CARLYLE-CARRIER SCROLL R-22 A/C COMPRESSORS

CAT#	MODEL	H.P.	BTU	Volts/Ph	Price Ea.
F13XCH34	XCH342HA01	3	34,000	460/60/3	\$495.00
F13SRH45	SRH452HC01	4	45,000	460/60/3	\$525.00
F13SRH48	SRH482AC01	4	48,000	460/60/3	\$550.00
F13XRH54	SRH542HA01	4.5	54,000	460/60/3	\$595.00

Member of
The Chicagoland
Chamber of
Commerce

Keep it Cool
with Coldparts.

COLDPARTS, INC.
4401 S. Western Blvd.
Chicago, IL 60609

New Website!
www.coldparts.com

SAVE BIG!!

Great Deals that
save you money, fast
shipping, all across
the USA!

ORDERING INFORMATION & COMPRESSOR GUARANTEE

Terms: We accept certified checks and money orders for payments. Also UPS COD payment by certified check and money order only. Open account terms are NET 10 Days, only if credit has been established.

Prices: Prices in this catalog supersede all previous issues and flyers. This catalog is valuable, it is full of money savings values. Save your customer money and increase your profit. You can beat inflation and higher prices when you "Cool-It" with Coldparts.

Guarantee: All merchandise in this catalog is sold on our policy of your complete satisfaction or your money back.

Compressor Warranty: All other compressors in this catalog are out of manufactures warranty and carry Coldparts warranty. Coldparts guarantees that all compresors that are out of manufacturers warranty, will run when installed in a clean dry system, and correct electrical components are used.

***COLDPARTS WILL NOT REPLACE COMPRESSORS DUE TO MOTOR BURNOUT, GROUND COMPRESSOR WINDINGS OR BROKEN SUCTION VALVES DUE TO LIQUID SLUGGING ON COMPRESSOR LOW SIDE.**

Shipping Information: All merchandise sold in this catalog and flyers is sold F.O.B. Chicago, Illinois. Shipped Freight Collect.

Damage & Returned Merchandise: Colparts assumes no responsibility for merchandise damaged during transit. Damaged claims should be made on the delivering carrier. No merchandise can be returned without written permission from Coldparts. 15% restocking fee on all returns.

Prices on Silver Alloy and Copper Tubing: Prices on silver alloys and copper tubing are based on world market price and are subject to change without notice.

Wholesale Only: We sell wholesale to contractors, appliance repair, and companies related to our industry. Possession of this catalog does not obligate us to accept an order nor does it constitute an offer to sell.

Use Our Toll Free Number 1-800-445-1281 to place your order, get information, or to request a quote, just ask for our telephone order department. One of our friendly people there will glad to help you in any way possible.

QUICK REFERENCE INDEX

<p>A "A" Coils, Evaporator 7,20 A/C Scroll Compressors 1,7,8,9,12 Access valves 28,2 Air Cond. Evaporators 7,20</p> <p>B Brazeing flux 31 Bullet piercing valves 29</p> <p>C Capacitor, Motor Start, Motor Run 12,13,25,26</p> <p>Charging manifold, refig. 23 Charging hose, refig. 23 Compressors, A/C 7,8,9,10,11,12 Compressors, Refrig. 3,4,5,6,15,19,34 Condensing Units, A/C 14,15,16,17,18 Contactors 27 Copper Tubing 30</p> <p>D Defrost Coolers 7 Defrost timers, domestic 25 Defrost switches, Termination 20 Dryers, liquid, suction line 22</p> <p>E Evaporator fan motors, commercial 20,21,22 Evaporators, commercial 7,20 Evaporator fan motors, domestic 26</p>	<p>E Fan Blades 31 Fittings, brass, copper 28,29 Filter Dryers 14 Full gauge controls 27 Flame Shield 32</p> <p>G Gauges, refrigeration 23,27</p> <p>H Harris Dyna-Flow solder 31 Heat seal stick, Laco 31</p> <p>L Leak detector, Refrigerant, Gas 29 Leak Repair Kit 29 Lucas Milhaupt silver Brazing 32</p> <p>M Motor, evaporator commercial 21 Motor, evaporator domestic 21 Motor, condenser fan 7,19,20 Motors, A/C blower 7</p> <p>Q Oil, Supco 88 29 Overload Protectors 22 Overload & Relay Kits 22</p> <p>P Pressure Controls, Dual 17 Potential Motor Starting Relays 27</p>	<p>R Refrigeration Compressors 3,4,5,6,15,19,34</p> <p>Relays, Current 20,22 Relays, Solid State PTC 22, 24 Relay Power Packs, start caps. 25 Rotary A/C Compressors 7,9,10,11,17</p> <p>S Solder, Silver brazing 31,32 Soldering fluxes 31 Solid State 3-N-1 Start Relay 25 Supco 88 oil 29</p> <p>T Tape, electrical, plastic 29 Thawzone, liquid dehydrant 29 Temperature controls 13,30 Time delay relay 28 Thermometers 24,31 Thermostatic Expansion Valves 30 Tools 23,26,30,32 Tube Cutters 30 Turbo Air Defrost Coolers 7</p> <p>U Universal RSS Air Switch 30</p> <p>V Vacuum pump oil 20 Vibration eliminators 28</p> <p>W Water cooled condensers 16</p>
---	---	---

About Our Prices

Prices on parts that carry the manufactures warranty are subject to change with out notice. Because of todays rapid inflation, rate prices may change between catalogs, our website will reflect current rate prices. When suppliers increase prices to us, we must increase prices to you. If prices go down, we will charge you the lower price. This does not apply to bargain priced merchandise. Usually we try to hold the low price of the item until it is sold out. So look very carefully at our surplus bargain merchandise to save money and increase your profits.

Domestic and Export Wholesale Distributors of Refrigeration - Air Conditioning - Heating - Motors - Parts & Supplies

We accept VISA, MASTERCARD, DISCOVER & AMEX CARDS



Hours (CST)

Monday - Friday: 8 AM - 5 PM

Saturday: 9 AM - 1 PM

Sunday: Closed

<p>DANFOSS-SECOP COMPRESSOR MDL# TL2.5G</p> <p>250 BTU @ -10F. 1/12 HP. Low temperature. For capillary tube. Comes with electrical and POE oil.</p> <p>Model No. TL2.5G</p> <p>Cat# F83TL25 Model: HP: 1/12 Volts: 115V Refrigerant: R-134A Mount: 4" x 6.5"</p> <p>Price Ea: \$89.00</p> 	<p>ASPERA COMPRESSOR MDL# B5128A</p> <p>H-MBP. Low starting torque. For capillary tube. Comes with electrical and POE oil.</p> <p>Model No. B5128A</p> <p>CAT.# A1C5128 HP: 1/8 Volts: 115V Refrigerant: R-12/R-134A Mount: 4" x 6.5"</p> <p>Price Ea: \$79.00</p> 	<p>DANFOSS-SECOP COMPRESSOR MDL# TLS4.5F</p> <p>400 BTU @ -10F. 1/8 HP. Low temperature. LST. For capillary tube. Comes with electrical and POE oil.</p> <p>Model No. TLS4.5F</p> <p>CAT.# F93TL45 HP: 1/8 Volts: 115V Refrigerant: R-134A Mount: 3" x 6-3/4"</p> <p>Price Ea: \$110.00</p> 
<p>SAMSUNG COMPRESSOR MDL# ML50CIY</p> <p>550 BTU @ -10F. 1/6 HP. Low torque. For capillary tube. Comes with electrical and POE oil. <i>Sweat connections.</i></p> <p>Model No. ML50CIY</p> <p>CAT.# F10ML50 HP: 1/6 Volts: 115V Refrigerant: R-134A Mount: 4" x 6.5"</p> <p>Price Ea: \$79.00</p> 	<p>EMBRACO COMPRESSOR MDL# EMI50HER</p> <p>500 BTU @ -10F. 1/6 HP. Low torque. For capillary tube. Comes with electrical and POE oil. <i>Sweat connections.</i></p> <p>Model No. EMI50HER</p> <p>CAT.# A1CEM50 HP: 1/6 Volts: 115V Refrigerant: R-134A Mount: 4" x 6.5"</p> <p>Price Ea: \$145.00</p> 	<p>DANFOSS-SECOP COMPRESSOR MDL# TF4CLX</p> <p>LBP-776 BTU / HBP-2632 BTU. 1/5 HP. HST. For capillary tube. Comes with electrical and POE oil.</p> <p>Model No. TF4CLX</p> <p>CAT.# A1CTL4CLX HP: 1/5 Volts: 115V Refrigerant: R-404A Mount: 4" x 6.5"</p> <p>Price Ea: \$145.00</p> 
<p>DANFOSS-SECOP COMPRESSOR MDL# NF5.5FX</p> <p>LBP-695 BTU / HBP-2500 BTU. 1/5 HP. HST. For capillary tube or TXV. Comes with electrical and POE oil.</p> <p>Model No. NF5.5FX</p> <p>CAT.# A1CNF55 HP: 1/5 Volts: 115V Refrigerant: R-134A Mount: 4" x 6.5"</p> <p>Price Ea: \$155.00</p> 	<p>EMBRACO COMPRESSOR MDL# EM65HNR</p> <p>LBP-721 BTU / HBP-3065 BTU. 1/5 HP. HST. For capillary tube or TXV. Comes with electrical and POE oil.</p> <p>Model: EM65HNR</p> <p>Cat# AA1CM65 HP: 1/5 Volts: 115V Refrigerant: R-134A Mount: 4" x 6.5"</p> <p>Price Ea: \$145.00</p> 	<p>DANFOSS-SECOP COMPRESSOR MDL# TFS4.5CLX</p> <p>LBP-921 BTU / HBP-3400 BTU. 1/4 HP. HST. For capillary tube or TXV. Comes with electrical and POE oil.</p> <p>Model: TFS4.5CLX</p> <p>Cat# A1CTFS45CLX HP: 1/4 Volts: 115-127V Refrigerant: R-404A Mount: 4" x 6.5"</p> <p>Price Ea: \$189.00</p> 
<p>DANFOSS-SECOP COMPRESSOR MDL# FF7.5GK</p> <p>LBP-600 BTU / HBP-2500 BTU. 1/6 HP. LST. For capillary tube. Comes with electrical and POE oil.</p> <p>Model No. FF7.5GK</p> <p>CAT.# A1CNF6 HP: 1/6 Volts: 115V Refrigerant: R-134A Mount: 4" x 6.5"</p> <p>Price Ea: \$135.00</p> 	<p>DANFOSS-SECOP COMPRESSOR MDL# TL4CNX-2</p> <p>3,217 BTU @ 45F. HBP HST For capillary tube. Comes with electrical and POE oil.</p> <p>Model No. TL4CNX-2</p> <p>CAT.# A1C4CNX2 HP: Volts: 115-127V Refrigerant: R-290A Mount: 4" x 6.5"</p> <p>Price Ea: \$ 279.00</p> 	<p>EMBRACO COMPRESSOR MDL# PW5.5K14</p> <p>Low Back Pressure-Medium Back Pressure. LST. For capillary tube. Comes with electrical and POE oil.</p> <p>Model No. PW5.5K14</p> <p>CAT.# A1CPW55 HP: 1/6 Volts: 115V Refrigerant: R-12/R-134A Mount: 4" x 6.5"</p> <p>Price Ea: \$115.00</p> 
<p>DANFOSS-SECOP COMPRESSOR MDL# NLY10CN</p> <p>LBP-2,023 BTU @ -10 / HBP-3,650 BTU @ 20+F. HST. For capillary tube. Comes with electrical and POE oil.</p> <p>Model No. NLY10CN</p> <p>CAT.# A1CNLYCN HP: 1/2 Volts: 115-127V Refrigerant: R-290A Mount: 4" x 6.5"</p> <p>Price Ea: \$349.00</p> 	<p>DANFOSS-SECOP COMPRESSOR MDL# KLF5.6CNH</p> <p>LBP-1,157 BTU @ -10 / MBP-2,080 BTU @ 20+F. HST. For capillary tube. Comes with electrical and POE oil.</p> <p>Model No. KLF5.6CNH</p> <p>CAT.# A1C6CNH HP: Volts: 115-127V Refrigerant: R-290A Mount: 4" x 6.5"</p> <p>Price Ea: \$295.00</p> 	<p>DANFOSS-SECOP COMPRESSOR MDL# NF11FX</p> <p>LBP-1100 BTU / HBP-4050 BTU. HST. For capillary tube or TXV. Comes with electrical and POE oil.</p> <p>Model No. NF11FX</p> <p>CAT.# A1CNF11 HP: 1/3 Volts: 115V Refrigerant: R-134A Mount: 4" x 6.5"</p> <p>Price Ea: \$200.00</p> 

<p>MATSUSHITA COMPRESSOR MDL# S24C40KAU6 - R-134A</p> <p>160 BTU @ -10F. For capillary tube, comes with electrical and POE oil.</p> <p>Model No. S24C40KAU6</p> <p>CAT.# F21S24 HP: 1/16 Volts: 115V Refrigerant: R-134A Mount: 4" x 6.5"</p> <p>Price Ea: \$85.00</p> 	<p>TECUMSEH COMPRESSOR MDL# AEA1320AXA - R-12 / R-134A</p> <p>200 BTU @ -10 F. Low temp. For capillary tube, comes with relay, overload, cover and POE oil.</p> <p>Model No. AEA1320AXA</p> <p>CAT.# A1C1320A HP: 1/12 Volts: 115V Refrigerant: R-12 / R-134A Mount:</p> <p>Price Ea: \$99.00</p> 	<p>TECUMSEH COMPRESSOR MDL# AZA0335YXA - R-134A</p> <p>350 BTU @20+F. Medium temp. For capillary tube, comes with relay, overload, cover and POE oil.</p> <p>Model No. AZA0335YXA</p> <p>CAT.# F540335 HP: 1/10 Volts: 115V Refrigerant: R-134A Mount: 4" x 6.5"</p> <p>Price Ea: \$85.00</p> 
<p>DANFOSS-SECOP COMPRESSOR MDL# BD80F</p> <p>Compressor only. No BD controller board included. DC INVERTER 12-24V.</p> <p>Model No. BD80F</p> <p>CAT.# A1CBD80</p> <p>Refrigerant: R-134A Mount: 4" x 6.5"</p> <p>Price Ea: \$110.00</p> 	<p>EMBRACO COMPRESSOR MDL# NE6210Z</p> <p>Medium Temperature. HST For TXV or capillary tube, comes with electrical and POE oil.</p> <p>Model No. NE6210Z</p> <p>CAT.# A1C6210Z2 HP: 1/3 Volts: 230V Refrigerant: R-134A Mount: 4" x 6.5"</p> <p>Price Ea: \$200.00</p> 	<p>TECUMSEH 1/2 HP A/C COMPRESSOR MDL# AE8458E - R-22</p> <p>5,800 BTU. High Temperature. Compressor only. Triangle mount included.</p> <p>Model No. AE8458E</p> <p>CAT.# F988458 HP: 1/2 Volts: 115V Refrigerant: R-22 Mount: Triangle mount</p> <p>Price Ea: \$99.00</p> 
<p>DANFOSS-SECOP COMPRESSOR MDL# FR6G</p> <p>LBP 650 BTU @-10F. Low temperature. For capillary tube with electrical and POE oil.</p> <p>Model No. FR6G</p> <p>CAT.# A1CFR6230 HP: 1/5 Volts: 230V Refrigerant: R-134A Mount: 4" x 6.5"</p> <p>Price Ea: \$79.00</p> 	<p>DANFOSS-SECOP COMPRESSOR MDL# FR8.5G</p> <p>LBP-800 BTU / HBP-3,000 BTU. HST for TXV or capillary tube with electrical and POE oil.</p> <p>Model No: FR8.5G</p> <p>CAT.# A1CFR85230 HP: 1/4 Volts: 230V Refrigerant: R-134A Mount: 4" x 6.5"</p> <p>Price Ea: \$99.00</p> 	<p>DANFOSS-SECOP COMPRESSOR MDL# SC12G</p> <p>LBP-921 BTU / HBP-3,400 BTU. HST For capillary tube or TXV, comes with electrical and POE oil.</p> <p>Model No. SC12G</p> <p>CAT.# A1CTSC12G230 HP: 1/3 Volts: 230V Refrigerant: R-134A Mount: 4" x 6.5"</p> <p>Price Ea: \$175.00</p> 
<p>DANFOSS-SECOP COMPRESSOR MDL# NF7MLX</p> <p>LBP 1,490 BTU-HBP 5,015 BTU. HST for capillary tube or TXV with electrical and POE oil.</p> <p>Model No. NF7MLX</p> <p>CAT.# A1C7MLX230 HP: 1/3 Volts: 230V Refrigerant: R-404A Mount: 4" x 6.5"</p> <p>Price Ea: \$185.00</p> 	<p>DANFOSS-SECOP COMPRESSOR MDL# NF9FX</p> <p>LBP-786 BTU @ -10 F / MBP-1,825 BTU @ 20+ F. HST. Compressor only. No electrical parts included.</p> <p>Model: NF9FX</p> <p>CAT.# A1C9FX230 HP: 1/4 Volts: 220-240V HZ: 50 HZ Refrigerant: R-134A</p> <p>Price Ea: \$89.00</p> 	<p>DANFOSS-SECOP 1/2 HP Compressor 115V / 1PH / 60HZ - R-404A</p> <p>LBP-2,000 BTU HBP-7,600 BTU. For TXV or capillary tube with electrical and POE oil.</p> <p>Model: SC12MLX</p> <p>CAT.# A1C12MLX HP: 1/2 Volts: 115V Refrigerant: R-404A Mount: 4" x 6.5"</p> <p>Price Ea: \$395.00 Sweat</p> 
<p>DANFOSS-SECOP COMPRESSOR MDL# SC12CLX</p> <p>LBP - 2,000 BTU / HBP - 7,600. HST for capillary tube or TXV with electrical and POE oil.</p> <p>Model No. SC12CLX</p> <p>CAT.# A1C12CLX230 HP: 1/2 Volts: 230V Refrigerant: R-404A Mount: 4" x 6.5"</p> <p>Price Ea: \$295.00</p> 	<p>DANFOSS-SECOP COMPRESSOR MDL# SC18MLX</p> <p>LBP - 3,000 BTU / HBP - 9,800 BTU. HST for capillary tube or TXV with electrical and POE oil.</p> <p>Model: SC18MLX</p> <p>CAT.# A1C18MLX230 HP: 3/4 Volts: 230V Refrigerant: R-404A Mount: 4" x 6.5"</p> <p>Price Ea: \$425.00 Sweat</p> 	<p>DANFOSS-SECOP COMPRESSOR 115V / 1PH / 60HZ - R-134A</p> <p>6,600 BTU @ 45+F. High starting torque. Medium temperature. HST for TXV or capillary tube with electrical and POE oil.</p> <p>Model: SC18G</p> <p>CAT.# A1C18G HP: 1/2 Volts: 115V Refrigerant: R-134A Mount: 4" x 6.5"</p> <p>Price Ea: \$400.00 Sweat</p> 

<p>DANFOSS-SECOP COMPRESSOR MDL# TL2.55</p> <p>L-MBP Low torque for capillary tube. Comes with electrical and POE oil.</p> <p>Model No. TL2.55 CAT.# A1CTL26230 HP: 1/12 Volts: 230V Refrigerant: R-134A Mount: 4" x 6.5"</p> <p>Price Ea: \$85.00</p> 	<p>DANFOSS-SECOP COMPRESSOR MDL# TL3G</p> <p>L-MBP Low torque for capillary tube. Comes with electrical and POE oil.</p> <p>Model No. TL3G CAT.# A1CTL32230 HP: 1/10 Volts: 230V Refrigerant: R-134A Mount: 4" x 6.5"</p> <p>Price Ea: \$85.00</p> 	<p>SANYO REFRIGERATION COMPRESSOR MDL# C-Q50M2C - R-12</p> <p>170 BTU @-10 F. Low Temp. Comes with overload, relay and oil charge. <i>No terminal cover.</i></p> <p>Model No.C-Q50M2C CAT.# HP: 1/16 Volts: 115V Refrigerant: R-12 Mount: 4" X 6.5"</p> <p>Price Ea: \$ 45.00</p> 
<p>ASPERA COMPRESSOR MDL# NB6152E</p> <p>2,500 BTU @ 45+F. HST. Medium temperature. With relay, overload, start cap, cover and POE oil charge.</p> <p>Model No. NB6152E CAT.# A1C6152E HP: 1/5 Volts: 115V Refrigerant: R-22/R-404A Mount: 4" x 6.5" / 8" H</p> <p>Price Ea: \$125.00</p> 	<p>TECUMSEH COMPRESSOR MDL# AKA9427ZXA</p> <p>2,700 BTU @ 20+F. HST. Medium temperature. With relay, overload, start cap, cover and mineral</p> <p>Model: AKA9427ZXA CAT.# F549427 HP: +1/3 Volts: 115V Refrigerant: R-404A/R-22 Mount: 4.8" x 8"</p> <p>Price Ea: \$295.00</p> 	<p>TECUMSEH COMPRESSOR MDL# HGA9443YXA</p> <p>4,300 BTU @20+F. High torque. Medium temperature. Very low profile with electrical and A-B oil charge.</p> <p>Model No. HGA9443YXA CAT.# F54443YA HP: 1/2 Volts: 115V Refrigerant: R-134A Mount: 5" x 8" / 7" High</p> <p>Price Ea: \$325.00</p> 
<p>COPELAND 1/3 HP Compressor 115V / 1PH / 60HZ - R-404A</p> <p>2,400 BTU @ 20+F. L-MBP. HST for TXV or capillary tube with electrical and POE oil.</p> <p>Model No. ASE24C5E-IAA CAT.# A1C24C5E HP: 1/3 Volts: 115V Refrigerant: R-404A Mount: 4" x 6.5"</p> <p>Price Ea: \$249.00</p> 	<p>LG 3/4 HP Rotary A/C Compressor 115V / 1PH / 60HZ - R-22</p> <p>9,400 BTU @ 45+F. HBP. AC compressor. Compressor only. No accessories.</p> <p>Model No. QK134CAB CAT.# F FQK134 HP: 3/4 Volts: 115V Refrigerant: R-22 Mount: 6" Mounting Centers</p> <p>Price Ea: \$99.00</p> 	<p>TECUMSEH COMPRESSOR MDL# HGA0470EXD</p> <p>7,000 BTU @20+F. Normal torque. Medium temperature. Very low profile with electrical and A-B oil charge.</p> <p>Model No. HGA0470EXD CAT.# F5404ED HP: 3/4 Volts: 230V Refrigerant: R-22 Mount: 5" x 8" / 7" High</p> <p>Price Ea: \$295.00</p> 
<p>COPELAND 1/2 HP Compressor 115V / 1PH / 60HZ - R-404A</p> <p>4,000 BTU @ 20+F. L-MBP. HST for TXV or capillary tube with electrical and POE oil.</p> <p>Model No. RST40C1E-CAA CAT.# A1C40C5E HP: 1/2 Volts: 115V Refrigerant: R-404A Mount: 4.8" x 8"</p> <p>Price Ea: \$400.00</p> 	<p>TECUMSEH COMPRESSOR MDL# HGA2434ZXA</p> <p>3,400 BTU @-10F. HST. Low temperature. Very low profile with electrical and A-B oil charge.</p> <p>Model No. HGA2434ZXA CAT.# F54HG34 HP: 3/4 Volts: 115V Refrigerant: R-404A Mount: 5" x 8" / 7" High</p> <p>Price Ea: \$325.00</p> 	<p>TECUMSEH COMPRESSOR MDL# HGA0440EXA</p> <p>4,000 BTU @20F. Normal torque. Medium temperature. Very low profile with electrical and A-B oil charge.</p> <p>Model No. HGA0440EXA CAT.# F540440 HP: 1/2 Volts: 115V Refrigerant: R-22 Mount: 5" x 8" / 7" High</p> <p>Price Ea: \$225.00</p> 
<p>DANFOSS-SECOP 1/2 HP Compressor 230V / 1PH / 50-60HZ - R-134A</p> <p>HST for TXV or capillary tube with electrical and POE oil.</p> <p>Model: SC15FT CAT.# A1SC15FT HP: 1/2 Volts: 230V HZ: 50-60 HZ Refrigerant: R-134A Mount: 4" x 6.5"</p> <p>Price Ea: \$325.00</p> 	<p>COPELAND 1/6 HP Compressor 115V / 1PH / 60HZ - R-404A</p> <p>1,280 BTU @ 20+F. L-MBP. HST for TXV or capillary tube with electrical and POE oil.</p> <p>Model No. ASB12C3E-IAA CAT.# A1C12C3E HP: 1/6 Volts: 115V Refrigerant: R-404A Mount: 4" x 6.5"</p> <p>Price Ea: \$135.00</p> 	<p>TECUMSEH COMPRESSOR MDL# HGA9468ZXD</p> <p>6,800 BTU @20+F. HST. Medium temperature. Very low profile with electrical and A-B oil charge.</p> <p>Model No. HGA9468ZXD CAT.# F54HG68 HP: 3/4 Volts: 230V Refrigerant: R-404A/R-22 Mount: 5" x 8" / 7" High</p> <p>Price Ea: \$325.00</p> 

<p>EMBRACO Refrigeration Compressor MDL# EMX3115U - 115-127V - R-290A</p> <p>EMBRACO refrigeration compressor. Low/Medium temperature.</p> <p>Model No. EMX3115U Cat# A1C3115U Model: Embraco HP: 1/5 Volts: 115-127V / 60HZ / 1PH Refrigerant: R-290A</p>  <p>Price Ea: \$229.00</p>	<p>EMBRACO Refrigeration Compressor MDL# NEU6217U - 115-127V - R-290A</p> <p>EMBRACO refrigeration compressor. Medium/High temperature.</p> <p>Model No. NEU6217U Cat# A1C6217U Model: Embraco HP: +1/2 Volts: 115-127V / 60HZ / 1PH Refrigerant: R-290A</p>  <p>Price Ea: \$479.00</p>	<p>EMBRACO Refrigeration Compressor MDL# NEU6181U - 115-127V - R-290A</p> <p>EMBRACO refrigeration compressor. Medium/High temperature.</p> <p>Model No. NEU6181U Cat# A1C6181U Model: Embraco HP: 1/3 Volts: 115-127V / 60HZ / 1PH Refrigerant: R-290A</p>  <p>Price Ea: \$279.00</p>
<p>SECOP Refrigeration Compressor MDL# TL4CNX.2 - 115-127V - R-290A</p> <p>SECOP refrigeration compressor. Low/Medium temperature.</p> <p>Model No. TL4CNX.2 Cat# A1C4CNX2 Model: SECOP HP: 1/5 Volts: 115-127V / 60HZ / 1PH Refrigerant: R-290A</p>  <p>Price Ea: \$279.00</p>	<p>SECOP 1/2 HP Refrigeration Compressor MDL# SC12CNX.2 - 115V - R-290A</p> <p>SECOP refrigeration compressor. Low/Medium/High temperature. LRA: 42</p> <p>Model No. SC12CNX.2 Cat# A1CSC12CNX Model: SECOP HP: 1/2 Volts: 115V / 60HZ / 1PH Refrigerant: R-290A</p>  <p>Price Ea: \$489.00</p>	<p>SECOP 1/2 HP Refrigeration Compressor MDL# NLY10CN - 115-127V - R-290A</p> <p>SECOP refrigeration compressor. Low/Medium/High temperature. Extended Temperature.</p> <p>Model No. NLY10CN Cat# A1CNLY10 Model: SECOP HP: 1/2 Volts: 115-127V / 60HZ / 1PH Refrigerant: R-290A</p>  <p>Price Ea: \$349.00</p>
<p>SECOP Refrigeration Compressor MDL# TL5CN - 220-240V - R-290A</p> <p>SECOP refrigeration compressor. Low/Medium temperature.</p> <p>Model No. TL5CN Cat# A1C5CN230 Model: SECOP HP: 1/5 Volts: 220-240V / 60HZ / 1PH Refrigerant: R-290A</p>  <p>Price Ea: \$279.00</p>	<p>SECOP Refrigeration Compressor MDL# TL4CN - 115-127V - R-290A</p> <p>SECOP refrigeration compressor. Low/Medium temperature.</p> <p>Model No. TL4CN Cat# A1CTL4CN Model: SECOP HP: 1/5 Volts: 115-127V / 60HZ / 1PH Refrigerant: R-290A</p>  <p>Price Ea: \$279.00</p>	<p>SECOP Refrigeration Compressor MDL# DLE4CN - 115-127V - R-290A</p> <p>SECOP refrigeration compressor. Low/Medium temperature.</p> <p>Model No. DLE4CN Cat# A1CDLE4CN Model: SECOP HP: 1/4 Volts: 115-127V / 60HZ / 1PH Refrigerant: R-290A</p>  <p>Price Ea: \$279.00</p>
<p>SECOP Refrigeration Compressor MDL# NLE13KTK - 115-127V - R-290A</p> <p>SECOP refrigeration compressor. Low/Medium temperature.</p> <p>Model No. NLE13KTK Cat# A1CNLE13KTK Model: SECOP HP: 1/2 Volts: 115-127V / 60HZ / 1PH Refrigerant: R-290A</p>  <p>Price Ea: \$279.00</p>	<p>DANFOSS-SECOP COMPRESSOR MDL# KLF5.6CNH</p> <p>LBP-1,157 BTU @ -10 / MBP-2,080 @ 20+F. HST. For capillary tube. Comes with electrical and POE oil.</p> <p>Model No. KLF5.6CNH CAT.# A1C56CN HP: +1/4 Volts: 115-127V Refrigerant: R-290A Mount: 4" x 6.5"</p>  <p>Price Ea: \$295.00</p>	<p>ASPERA COMPRESSOR MDL# B5128A</p> <p>H-MBP. Low starting torque. For capillary tube. Comes with electrical and POE oil.</p> <p>Model No. B5128A CAT.# A1C5128 HP: 1/8 Volts: 115V Refrigerant: R-12 / R-134A Mount: 4" x 6.5"</p>  <p>Price Ea: \$79.00</p>

Rotary Air Conditioning and Heat Pump Compressors - R-22

CAT.#	MODEL	MANUFACTURER	HP	BTU	VOLTS/HZ/PH	PRICE EA.
F6903	RGB5472EXA	Tecumseh	3/4	7,200	115/60/1	\$65.00
F545492	RGA5492EXA	Tecumseh	3/4	9,200	115/60/1	\$99.00
F102P16	2P16S3R126B	Matsushita	3/4	10,735	115/60/1	\$135.00
FQK145	QK145CGJ	LG	3/4	10,000	115/60/1	\$99.00
F545490ED	RKA5490EXD	Tecumseh	3/4	9,000	230/60/1	\$149.00
F10CR101	C-R101H2H	Sanyo	1	13,300	115/60/1	\$159.00
F10CR220	C-R220H6B	Sanyo	2.5	32,000	230/60/1	\$275.00

All compressors -3 leg mount with cover and overload.



LG Scroll Air Conditioning Compressors - R-410A

230V / 1 PH / 60 HZ

CAT.#	MODEL	HP	BTU	VOLTS/HZ/PH	PRICE EA.
F13029K1	APA029KAB	2.50	29,000	230/60/1	\$385.00
F13030K1	APA030KAA	2.50	30,000	230/60/1	\$385.00
F13031K1	APG031KAC	2.50	31,000	230/60/1	\$425.00
F13038K1	AQA038KAA	3.25	38,000	230/60/1	\$450.00
F13039K1	AQA039KAA	3.25	39,000	230/60/1	\$450.00
F13040K1	AQA040KAA	3.25	40,000	230/60/1	\$475.00
F13042K1	AQA042KAB	3.50	42,000	230/60/1	\$495.00
F13049K1	ABG049KAA	4	49,000	230/60/1	\$650.00
F13051K1	ABA051KAE	4.25	51,000	230/60/1	\$695.00



All Compressors Mounting: 7.5" x 7.5"

R-410A ONLY

Elco Motors - 6W - 9W - 16W

115V / 230V

WATTS	VOLTS	AMPS	MODEL #	PRICE EA.
6	115	0.41	EC-6W115	\$79.00
6	230	0.20	EC-6W230	\$79.00
9	115	0.58	EC-9W115	\$89.00
9	230	0.35	EC-9W230	\$89.00
16	115	1.00	EC-16W115	\$99.00
16	230	0.50	EC-16W230	\$99.00



Carrier Universal PSC Blower - Fan Motors

1075 RPM - 230V

Model No. HC52AE209

CAT.# F90052S

HP: 1

Volts: 230V / 60 HZ / 1 PH

RPM: 1075 - 3 speed

Shaft Length: 4" long

Shaft Diameter: 1/2" OD

Rotation: CCW Lead End

Price Ea: \$99.00



TURBO AIR Low Profile Defrost Coolers for R-404A - ADR & LED Models 115V - 208-230V

Model No. ADR060AEOM

CAT.# 30060M

6,058 BTU 6FPI 115/1/60
Low Profile Air Defrost w/ECM Motor TXV R-404A and Solinoid.

Single Fan.

Dim: 29-3/8" L x 13-13/16" W x 15" H.

Price Ea: \$1,345.00

Model No. ADR137AEOM

CAT.# 30137M

13,744 BTU 6FPI 115/1/60
Low Profile Air Defrost w/ECM Motor TXV R-404A and Solinoid.

Three Fans.

Dim: 61-3/8" L x 13-13/16" W x 15" H.

Price Ea: \$2,145.00

Model No. LED052BEOM

CAT.# 30052L

5,247 BTU 6FPI 208-230/1/60
Low Profile Electric Defrost w/ECM TXV R-404A and Solinoid.

Two Fans.

Dim: 45-3/8" L x 13-13/16" W x 15" H.

Price Ea: \$1,910.00

Model No. LED090BEOM

CAT.# 30090L

9,027 BTU 6FPI 208-230/1/60
Low Profile Electric Defrost w/ECM TXV R-404A and Solinoid.

Three Fans.

Dim: 61-3/8" L x 13-13/16" W x 15" H.

Price Ea: \$2,420.00

Model No. ADR089AEOM

CAT.# 30089M

8,989 BTU 6FPI 115/1/60
Low Profile Air Defrost w/ECM Motor TXV R-404A and Solinoid.

Two Fans.

Dim: 45-3/8" L x 13-13/16" W x 15" H.

Price Ea: \$1,565.00

Model No. ADR171AEOM

CAT.# 30137M

17,213 BTU 6FPI 115/1/60
Low Profile Air Defrost w/ECM Motor TXV R-404A and Solinoid.

Three Fans.

Dim: 61-3/8" L x 13-13/16" W x 15" H.

Price Ea: \$2,565.00

Model No. LED072BEOM

CAT.# 30072L

7,244 BTU 6FPI 208-230/1/60
Low Profile Electric Defrost w/ECM TXV R-404A and Solinoid.

Two Fans.

Dim: 45-3/8" L x 13-13/16" W x 15" H.

Price Ea: \$2,055.00



BRISTOL H22G-H92G COMPRESSORS

S* - SWEAT CONNECTIONS
R* - ROTO LOCK CONNECTIONS

FOR A/C AND HIGH TEMP APPLICATIONS

ALL COMPRESSORS THAT NEED MODULES ARE INCLUDED



R-22 / R-407C

CAT.#	MODEL	HP	BTU	OIL	VOLTS/HZ/PH	PRICE EA.
A1C094-4	H2NG094DPEE-S*	7.5	94,000	MINERAL	460/60/3	\$1,095.00
A2CG094-4	H22G094DBEE-S*	7.5	94,000	MINERAL	460/60/3	\$1,095.00
A2CG104-4	H2BG104DBEE-R*	9	104,000	MINERAL	460/60/3	\$1,195.00
A2CG124-3	H22G124DBDE-S*	10	120,000	POE	230/60/3	\$1,295.00
A2CG184-3	H92G184DPDF-S*	15	184,000	POE	230/60/3	\$1,695.00
A2CG244-3	H92G244FRDF-R*	20	244,000	POE	230/60/3	\$1,995.00
A2CG294-3	H22G294FPDF-S*	24	294,000	MINERAL	230/60/3	\$2,095.00

BRISTOL 4-1/2 HP Two Stage A/C Compressor
230V - R-410A

51,000 BTU. Two Stage A/C Compressor. 4.5 Ton. POE Oil.

Model No. T89A515BBCA

CAT.# F13T89A51
HP: 4-1/2
Volts: 230V
HZ: 60
PH:1
Refrigerant: R-410A
Mount: 7.5" x 7.5"



Price Ea: \$695.00

CARRIER Scroll Compressor - DC INVERTER
MDL# GC13YN001 - 120-225V - R-410A

DC INVERTER. Carrier Scroll Compressor.

Model No. GC13YN001

CAT.# F13YN001
Volts: 120-225V
Refrigerant: R-410A



Price Ea: \$699.00

Danfoss 3/4 HP Refrigeration Compressor
MDL# MX18TE

5,500 BTU @ 20+ F. Refrigerator compressor. Medium/High Temperature. With POE oil and cover.

Model No. MX18TE

CAT.# A1CMX18T
HP: 3/4 HP
Volts: 115V
HZ: 60
PH:1
Refrigerant: R-404A



Price Ea: \$395.00

LG 2 HP Scroll A/C Compressor
208-230V / 1 PH / 60 HZ - R-22

22,000 BTU. LG A/C Scroll compressor. With mineral oil. 1/2" Liquid - 3/4" Suction.

Model No. SQA022KAC

CAT.# F13022SQ
HP: 2
Volts: 208-230V
HZ: 60
PH: 1
Refrigerant: R-22
Mount: 7.5" x 7.5" / 16" High



Price Ea: \$395.00

LG SCROLL A/C Compressor
208-230V / 1 PH / 60 HZ - R-22

32,000 BTU. LG A/C Scroll compressor. 4 TON. With mineral oil. 1/2" Liquid - 7/8" Suction.

Model No. SQA032KAC

CAT.# F13032SQ
HP: 2-1/2
Volts: 230V
HZ: 60
PH:1
Refrigerant: R-22
Mount: 7.5" x 7.5" / 17" High



Price Ea: \$450.00

LG SCROLL A/C Compressor
MDL# SQA038KAC

38,000 BTU. LG Scroll A/C compressor. With mineral oil. 1/2" Liquid - 7/8" Suction.

Model No. SQA038KAC

CAT.# F13038SQ
HP: 3-1/4
Volts:208- 230V
HZ: 60
PH: 1
Refrigerant: R-22
Mount: 7.5" x 7.5" - 17" High



Price Ea: \$595.00

LG SCROLL A/C Compressor
MDL# ABG051KAE

51,000 BTU. LG Scroll A/C compressor.

Model No. ABA051KAE

CAT.# F13051K1
HP: 4-1/2
Volts: 230V
HZ: 60
PH:1
Refrigerant: R-410A
Mount: 7.5" x 7.5" - 17" High



Price Ea: \$695.00

LG 1.5 HP Scroll Compressor
208-230V / 1PH / 60HZ - R-404A

LG Refrigeration scroll compressor. Medium Temp. With electrical box, 7/8" suction valve with POE oil.

Model No. MBA013KAC

CAT.# A1MBA013
HP: 1.5
Volts: 208-230V
HZ: 60
PH:1
Refrigerant: R-404A
Mount: 7.5" X 7.5"



Price Ea: \$750.00 - w/Sweat
Price Ea: \$795.00 - w/Valve

SAMSUNG 2-1/2 HP Rotary A/C Compressor - 208-230V / 1 PH / 60 HZ - R-410A

29,000 BTU. 4 Ton. For A/C 6" Triangle mount. With POE oil and cover.

Model No. UG5A290INZJ2

CAT.# A2CH82J48
HP: 2-1/2
Volts: 208-230V
HZ: 60
PH:1
Refrigerant: R-410A
Mount: 4" x 6.5" - 17" High



Price Ea: \$190.00

**PANASONIC ROTARY COMPRESSORS
FOR R-410A MINI-SPLIT A/C'S DC FOR INVERTER SYSTEM**

CAT.#	MODEL	HP	BTU	VOLTS	PRICE EA.
A2C5KD24	5KD240XAC21	2	24,000	DC 280V	\$295.00
A2C5JD42	5JD420XAC22	3.5	42,000	DC 280V	\$295.00



**TOSHIBA ROTARY COMPRESSORS
FOR R-410A MINI-SPLIT A/C'S DC FOR INVERTER SYSTEM**

CAT.#	MODEL	HP	BTU	VOLTS	HZ	PRICE EA.
F13DA150	DA150A1F-21F1	1.5	15,000	DC 171V	120	\$195.00
F13DA220	DA220A2F-23L	2	25,000	DC 200V	120	\$275.00
F13DA330	DA330A2F-20M	3	35,000	DC 197V	120	\$295.00
F13DA422	DA422A3F-26M	4	46,000	DC 173V	120	\$350.00

**TECUMSEH 1 HP Compressor
230V / 3PH / 60HZ - R-134A / R-12**

Tecumseh Refrigeration compressor. Medium-Temp. HST. 3 phase with POE Oil charge and 7/8" suction Roto-Lock valve.

Model No. AHA7480AXF

CAT.# F547480F
HP: 1
Volts: 230V
HZ: 60
PH: 3
Refrigerant: R-134A/R-12
Mount: 7.5" x 7.5"



Price Ea: \$595.00

**COPELAND 1 HP Compressor w/valve
230V / 1PH / 60HZ - R-404A**

8,200 BTU @ 20+F. Copeland Refrigeration compressor. Medium Temp. Comes with electrical box and POE oil. *Valve connections.*

Model No. ZB08KAE-PFV

CAT.# A1ZB08V
HP: 1
Volts: 230V
HZ: 60
PH:1
Refrigerant: R-404A
Mount: 7.5" X 7.5"



Price Ea: \$695.00

**COPELAND 1 HP Compressor w/valve
230V / 1PH / 60HZ - R-404A**

8,200 BTU @ 20+F. Copeland Refrigeration compressor. Medium Temp. Comes with electrical box and POE oil. *Valve connections.*

Model No. ZS09KAE-PFV

CAT.# A1ZS09V
HP: 1
Volts: 230V
HZ: 60
PH:1
Refrigerant: R-404A
Mount: 7.5" X 7.5"



Price Ea: \$650.00 - w/Sweat
Price Ea: \$695.00 - w/Valve

**TECUMSEH 1 HP Compressor
230V / 3PH / 60HZ - R-134A / R-12**

Tecumseh Refrigeration compressor. Low Temp. HST for expansion valve systems. 3 phase with POE Oil charge and 7/8" suction Roto-Lock valve.

Model No. AHA2445AXF

CAT.# F542445F
HP: 1
Volts: 230V
HZ: 60
PH: 3
Refrigerant: R-134A/R-12
Mount: 7.5" x 7.5"



Price Ea: \$425.00

**COPELAND 1 HP Compressor
230V / 1PH / 60HZ - R-404A**

8,200 BTU @ 20+F. Copeland Refrigeration compressor. Medium Temp. Comes with electrical box and POE oil. *OD sweat connections.*

Model No. ZB08KAE-PFV

CAT.# A1ZB08S
HP: 1
Volts: 230V
HZ: 60
PH: 1
Refrigerant: R-404A
Mount: 7.5" X 7.5"

High side check valve: \$30.00



Price Ea: \$650.00 - Sweat

**COPELAND +3/4 HP Compressor
230V / 1PH / 60HZ - R-404A / R-22**

7,500 BTU @ 20+F. Copeland Refrigeration compressor. L-MBP. Comes with electrical box. 5/8" suction valve with POE oil.

Model No. ZB07KAE-PFV

CAT.# A1ZB07V
HP: +3/4
Volts: 230V
HZ: 60
PH:1
Refrigerant: R-404A / R-22

High side check valve: \$30.00



Price Ea: \$625.00 - w/Sweat
Price Ea: \$675.00 - w/Valve

**COPELAND 2 HP Compressor
230V / 1PH / 60HZ - R-404A**

15,000 BTU @ 20+F. Copeland Refrigeration compressor. Medium Temp. With electrical box, 7/8" suction valve with POE oil.

Model No. ZB15KCE-PFV

CAT.# A1ZB15V
HP:2
Volts: 230V
HZ: 60
PH: 1
Refrigerant: R-404A



Price Ea: \$850.00 - w/Sweat
Price Ea: \$895.00 - w/Valve

**COPELAND 2.5 HP Compressor
230V / 1PH / 60HZ - R-404A**

18,600 BTU @ 20+F. Copeland Refrigeration compressor. Medium Temp. With electrical box, 7/8" suction valve with POE oil.

Model No. ZB19KCE-PFV

CAT.# A1ZB19V
HP: 2-1/2
Volts: 230V
HZ: 60
PH:1
Refrigerant: R-404A



Price Ea: \$850.00 - w/Sweat
Price Ea: \$895.00 - w/Valve

**LG 3 HP Rotary Compressor
230V / 1PH / 60HZ - R-404A**

21,000 BTU @ 20+ F. LG Refrigeration compressor. Medium Temp. With electrical box, 7/8" suction valve with POE oil.

Model No. MBA021KAB

CAT.#
HP: 3
Volts: 208-230V
HZ: 60
PH:1
Refrigerant: R-404A



Price Ea: \$950.00 - w/Sweat
Price Ea: \$995.00 - w/Valve

<p>TECUMSEH ROTARY COMPRESSOR MDL# RGB5472EXA - 115V / 60HZ / 1 PH - R-22</p> <p>7,200 BTU @ 45°F. Comes with overload, cover and oil charge. 3 leg mount.</p> <p>Model No. RGB5472EXA</p> <p>Cat# F6903 Model: HP: 3/4 Volts: 115V Refrigerant: R-22</p>  <p>Price Ea: \$65.00</p>	<p>ROTO-REX ROTARY COMPRESSOR MDL# C101C038 - 115V / 60HZ / 1 PH - R-22</p> <p>10,000 BTU @ 45°F. Comes with overload, cover and oil charge. 3 leg mount.</p> <p>Model No. C101C038</p> <p>CAT# F68C038 HP: 3/4 Volts: 115V Refrigerant: R-22</p>  <p>Price Ea: \$70.00</p>	<p>SAMSUNG ROTARY COMPRESSOR MDL# 44A085HW - 115V / 60HZ / 1 PH - R-22</p> <p>8,500 BTU @ +45F. Comes with overload, cover and oil charge. 3 leg mount</p> <p>Model No. 44A085HW</p> <p>CAT# F681071 HP: 3/4 Volts: 115V Refrigerant: R-22</p>  <p>Price Ea: \$79.00</p>
<p>TECUMSEH Rotary Compressor MDL# RKA5490EXD - 230V / 1PH / 60HZ - R-22</p> <p>9,000 BTU. For R-22 with electrical cover and oil charge. Tri-angle mount. Air conditioning, Mini-Split and Heat pump application. Overload protection.</p> <p>Model: RKA5490EXD</p> <p>CAT# F545490D HP: 9,000 BTU Volts: 208-230V Refrigerant: R-22 Mount: 6"</p>  <p>Price Ea: \$149.00</p>	<p>LG ROTARY COMPRESSOR MDL# QK145CGJ - 115V / 60HZ / 1 PH - R-22</p> <p>10,000 BTU @ +45F. Comes with overload, cover and oil charge. 3 leg mount.</p> <p>Model No. QK145CGJ</p> <p>CAT# F54QK145 HP: Volts: 115V Refrigerant: R-22</p>  <p>Price Ea: \$99.00</p>	<p>LG ROTARY COMPRESSOR MDL# QK164CBE - 115V / 60HZ / 1 PH - R-22</p> <p>11,300 BTU @ +45F. Comes with overload, cover and oil charge. 3 leg mount.</p> <p>Model No. QK164CBE</p> <p>CAT# F54QK164 HP: 1 Volts: 115V Refrigerant: R-22</p>  <p>Price Ea: \$179.00</p>
<p>TECUMSEH ROTARY COMPRESSOR MDL# RGA5492EXA - 115V / 60HZ / 1 PH - R-22</p> <p>9,200 BTU @ +45F. Comes with overload, cover and oil charge. 3 leg mount.</p> <p>Model No. RGA5492EXA</p> <p>CAT# F545492 HP: 3/4 Volts: 115V Refrigerant: R-22</p>  <p>Price Ea: \$99.00</p>	<p>MATSUSHITA ROTARY COMPRESSOR MDL# 2R7S3R126A - 115V / 60HZ / 1 PH - R-22</p> <p>5,000 BTU @ +45F. Comes with overload, cover and oil charge. 3 leg mount.</p> <p>Model No. 2R7S3R126A</p> <p>CAT.# F681082 HP: 1/2 Volts: 115V Refrigerant: R-22</p>  <p>Price Ea: \$45.00</p>	<p>PANASONIC ROTARY COMPRESSOR MDL# 5KD240XAC21 - 280V / 60HZ / 1 PH - R-410A</p> <p>24,000 BTU @ +45F. For inverter style mini-split A/C systems. Comes with cover, rubber feet and POE oil charge.</p> <p>Model: 5KD240XAC21</p> <p>Cat# A1CTFS45CLX HP: 2 Volts: 280V DC Refrigerant: R-410A Mount: 7.5" x 7.5" Square mount</p>  <p>Price Ea: \$250.00</p>
<p>PANASONIC ROTARY COMPRESSOR MDL# 5JD420XAC22 - 280V / 60HZ / 1 PH - R-410A</p> <p>42,000 BTU @ +45F. For inverter style mini-split A/C systems. Comes with cover, rubber feet and POE oil charge.</p> <p>Model: 5JD420XAC22</p> <p>Cat# A1CTFS45CLX HP: 3-1/2 Volts: 280V DC Refrigerant: R-410A Mount: 7.5" x 7.5" Square mount</p>  <p>Price Ea: \$295.00</p>	<p>SAMSUNG ROTARY COMPRESSOR MDL# UG5A290INZJ2 - 230V / 60HZ / 1 PH - R-22</p> <p>29,000 BTU @ +45F. Comes with overload, cover and oil charge. 3 leg mount.</p> <p>Model No: UG5A290INZJ2</p> <p>CAT.# A2C290 HP: 2-1/2 Volts: 230V Refrigerant: R-410A</p>  <p>Price Ea: \$190.00</p>	<p>ROTO-REX ROTARY COMPRESSOR MDL# K48A101AS-003 - 115V - R-22</p> <p>10,000 BTU @ 45°F. High Temperature. Comes with overload, cover and oil charge. 3 leg mount.</p> <p>Model No: K48A101AS-003</p> <p>CAT.# F68K48A101 BTU: 10,000 Volts: 115V Refrigerant: R-22</p>  <p>Price Ea: \$89.00</p>
<p>SANYO ROTARY COMPRESSOR MDL# C-2R160H6H - 208-230V / 60HZ / 1 PH - R-22</p> <p>25,000 BTU @ 45°F. High Temperature. Comes with overload, cover and oil charge. 3 leg mount.</p> <p>Model No: C-2R160H6H</p> <p>CAT.#F68C2R160 HP: 2-1/2 Volts: 208-230V Refrigerant: R-22</p>  <p>Price Ea: \$395.00</p>	<p>SANYO ROTARY COMPRESSOR MDL# C-2R180H6G - 208-230V / 60HZ / 1 PH - R-22</p> <p>28,000 BTU @ 45°F. High Temperature. Comes with overload, cover and oil charge. 3 leg mount.</p> <p>Model No: C-2R180H6G</p> <p>CAT.# F68C2R180 HP: 2-1/2 Volts: 208-230V Refrigerant: R-22</p>  <p>Price Ea: \$395.00</p>	<p>SANYO ROTARY COMPRESSOR MDL# C-R220H6B - 208-230V / 60HZ / 1 PH - R-22</p> <p>32,000 BTU @ 45°F. High Temperature. Comes with overload, cover and oil charge. 3 leg mount.</p> <p>Model No: C-R220H6B</p> <p>CAT.# F68R220 HP: 2-3/4 Volts: 208-230V Refrigerant: R-22</p>  <p>Price Ea: \$495.00</p>

<p>SANYO ROTARY COMPRESSOR MDL# C-1R37H2J - 115V / 60HZ /1 PH - R-22</p> <p>5,000 BTU @ 45°F. High Temperature. Comes with overload, cover and oil charge. 3 leg mount.</p> <p>Model No. C-1R37H2J</p> <p>CAT.# F68C1R37 BTU: 5,000 Volts: 115V Refrigerant: R-22</p>  <p>Price Ea: \$45.00</p>	<p>EMBRACO COMPRESSOR MDL# FF112HBX2 - 230V / 60HZ /1 PH - R-22</p> <p>Low-Medium back pressure. High torque with electrical, POE oil charge and sweat connections. Steel Lines.</p> <p>Model No. FF112HBX2</p> <p>CAT.# A1CFF112-2 HP: 1/3 Volts: 230V Refrigerant: R-134A Steel Lines</p>  <p>Price Ea: \$135.00</p>	<p>EMBRACO COMPRESSOR MDL# NE6210Z - 230V / 60HZ /1 PH - R-134A</p> <p>Medium Temperature. High starting torque for TXV or capillary tube. Comes with electrical, POE oil charge and sweat connections.</p> <p>Model No. NE6210Z</p> <p>CAT.# F681071 HP: 1/3 Volts: 230V Refrigerant: R-134A</p>  <p>Price Ea: \$200.00</p>
<p>TECUMSEH ROTARY COMPRESSOR MDL# RGB5460EXA - 115V / 60HZ /1 PH - R-22</p> <p>6,000 BTU @ +45F. Comes with overload, cover and oil charge. 3 leg mount.</p> <p>Model No. RGB5460EXA</p> <p>CAT.# F545460 HP: 1/2 Volts: 115V Refrigerant: R-22</p>  <p>Price Ea: \$79.00</p>	<p>TECUMSEH ROTARY COMPRESSOR MDL# RGA5450EXA - 115V / 60HZ /1 PH - R-22</p> <p>5,000 BTU @ +45F. Comes with overload, cover and oil charge. 3 leg mount.</p> <p>Model No. RGA5450EXA</p> <p>CAT.# F545450 HP: 1/2 Volts: 115V Refrigerant: R-22</p>  <p>Price Ea: \$59.00</p>	<p>MATSUSHITA ROTARY COMPRESSOR MDL# 2P16C3R126A - 115V / 60HZ /1 PH - R-22</p> <p>10,735 BTU @ +45F. Comes with overload, cover and oil charge. 3 leg mount.</p> <p>Model No. 2P16C3R126A</p> <p>CAT.# F682P16 HP: Volts: 115V Refrigerant: R-22</p>  <p>Price Ea: \$149.00</p>
<p>TECUMSEH ROTARY COMPRESSOR MDL# RGA5467EXA - 115V / 60HZ /1 PH - R-22</p> <p>6,700 BTU @ +45F. Comes with overload, cover and oil charge. 3 leg mount.</p> <p>Model No. RGB5467EXA</p> <p>CAT.# F545467 HP: 1/2+ Volts: 115V Refrigerant: R-22</p>  <p>Price Ea: \$65.00</p>	<p>TOSHIBA ROTARY COMPRESSOR MDL# ERH68XA3-1K - 115V / 60HZ /1 PH - R-22</p> <p>6,800 BTU @ +45F. Comes with overload, cover and oil charge. 3 leg mount.</p> <p>Model No. ERH68XA3-1K</p> <p>CAT.# F54ERH68 HP: 1/2+ Volts: 115V Refrigerant: R-22</p>  <p>Price Ea: \$65.00</p>	<p>TOSHIBA ROTARY COMPRESSOR MDL# ERH62XA3-1K - 115V / 60HZ /1 PH - R-22</p> <p>6,200 BTU @ +45F. Comes with overload, cover and oil charge. 3 leg mount.</p> <p>Model: ERH62XA3-1K</p> <p>Cat# F54ERH62 HP: 1/2 Volts: 115V Refrigerant: R-22</p>  <p>Price Ea: \$65.00</p>
<p>SAMSUNG ROTARY COMPRESSOR MDL# 44B102HW1E5 - 115V / 60HZ /1 PH - R-22</p> <p>10,200 BTU @ +45F. Comes with, overload, cover and oil charge.</p> <p>Model: 44B102HW1E5</p> <p>Cat# F54102HW HP: 3/4 Volts: 115V Refrigerant: R-22 Mount: 3 Leg mount</p>  <p>Price Ea: \$99.00</p>	<p>SAMSUNG ROTARY COMPRESSOR MDL# 44A056HV1A1 - 115V / 60HZ /1 PH - R-22</p> <p>5,600 BTU @ +45F. Comes with overload, cover and oil charge. 3 leg mount.</p> <p>Model No. 44A056HV1A1</p> <p>CAT.# F54056H HP: 1/2 Volts: 115V Refrigerant: R-22</p>  <p>Price Ea: \$39.00</p>	<p>SANYO ROTARY COMPRESSOR MDL# C-1R75H2U - 115V / 60HZ /1 PH - R-22</p> <p>9,800 BTU @ 45°F. High Temperature. Comes with overload, cover and oil charge. 3 leg mount.</p> <p>Model No. C-1R75H2U</p> <p>CAT.# F54C1R75 BTU: 9,800 Volts: 115V Refrigerant: R-22</p>  <p>Price Ea: \$89.00</p>

SAMSUNG ROTARY COMPRESSORS FOR A/C AND HEAT PUMPS



All compressors for R-410A application. Comes with internal overload, POE oil charge.

CAT#	MODEL #	HP	BTU	VOLTS/PH	PRICE
A2C200	UG5C2001NXJ2	1-3/4	20,000	230/1/60	\$250.00
A2C260	UG5C2601NZF2	2	26,000	230/1/60	\$265.00
A2C290	UG5A290INZJ2	2-1/4	29,000	230/1/60	\$190.00
A2C320	UG5T3201UZF2	2-1/2	32,000	230/1/60	\$350.00

Bristol H82J Air Conditioning Compressors - R-410A

CAT.#	MODEL	HP	BTU	VOLTS/HZ/PH	PRICE
A2CH82J18	H82J18BABCA	1.5	18,000	230/60/1	\$375.00
A2CH82J21	H82J213ABCA	2	21,000	460/60/1	\$395.00
A2CH82J24	H82J243ABCA	2	24,000	230/60/1	\$395.00
A2CH82B36	H82B363ABCA	3	36,000	230/60/1	\$475.00
A2CH82J40	H82J403ABCA	3.5	40,000	230/60/1	\$495.00
A2CH82J44	H82J443ABCA	3.75	44,000	230/60/1	\$595.00



P - POE oil charge
S* - Sweat Connections
R* - Roto Lock Connections
Set service valves extra \$250.00

Mounting: 7.5" x 7.5"

Bristol H22G-H92G Air Conditioning Compressors - R-22

CAT.#	MODEL	HP	BTU	VOLTS/HZ/PH	PRICE EA.
A2CH22A54-4	H22A543DBEA	4.5	54,000	460/60/3	\$525.00
A1C094-4	H2NG094DPEE-S*	7.5	94,000	460/60/3	\$1,095.00
A2CG094-4	H22G094DBEE-S*	7.5	94,000	460/60/3	\$1,095.00
A2CG104-4	H2BG104DBEE-R*	9	104,000	460/60/3	\$1,195.00
A2CG144-4	H22G144DBEE-S*	12	144,000	460/60/3	\$1,395.00
A2CG184-3	H92G184DPDF-PS*	15	184,000	230/60/3	\$1,695.00
A2CG244-3	H92G244FRDF-PR*	20	244,000	230/60/3	\$1,995.00
A2CG294-3	H22G294FPDF-S*	24	294,000	230/60/3	\$2,095.00

For A/C & High Temperature Applications

R-22 / R-407C



LG Scroll Air Conditioning Compressors - R-410A

CAT#	MODEL	HP	BTU	VOLTS/HZ/PH	PRICE EA.
F13029K1	APA029KAB	2.5	29,000	230/60/1	\$385.00
F13030K1	APA030KAA	2.5	30,000	230/60/1	\$385.00
F13031K1	APA031KAC	2.5	31,000	230/60/1	\$425.00
F13038K1	AQA038KAA	3.25	38,000	230/60/1	\$450.00
F13039K1	AQA039KAA	3.25	39,000	230/60/1	\$450.00
F13040K1	AQA040KAA	3.25	40,000	230/60/1	\$475.00
F13042K1	AQA042KAB	3.5	42,000	230/60/1	\$495.00
F13049K1	ABG049KAA	4	49,000	230/60/1	\$650.00
F13051K1	ABA051KAE	4.25	51,000	230/60/1	\$695.00



RELAY-OVERLOAD-START CAPACITOR HI-TORQUE COMPRESSOR START KIT

1/3 HP 115V. Hi-Torque compressor start kit. Relay with capacitor connection. For Models: AEA2410YXA-AXA, AEA24112XA, AEA4440YXA-AXA.

CAT.# F5416



Price Ea: 19.95

RBM Relay SPST 24V Coil

1 HP 125V/ 2 HP 230V 18 LRA. Used to control blower motors in furnace and air conditioners. Fit 1/2" hole in all type of electrical boxes.

Model: 129515-3180ZL

CAT.# F98824



Price Ea: \$30.00

5 PIECE BARGAIN MOTOR ASSORTMENT

All Motors are NEW!

230V / 115V / 60HZ

Coldparts purchases thousands of air conditioning, blower, fan and general purpose motors that we advertise in our catalogs and website. When we sell out to the last few we offer them to our customers in this "BARGAIN MOTOR ASSORTMENT". These motors are offered to you at prices so low you can't afford to pass up this bargain. One or two motors can easily cost you more than \$50.00 if you had to buy them at today's wholesale prices.

5 PCS.

CAT.# A1M182

Price Ea: \$75.00



LIMITED QUANTITY ORIGINAL O.E.M. REPLACEMENT COMPRESSORS

CAT.#	MODEL	MFG.	HP	BTU	APPLICATION	STYLE	PRICE EA.
F9818	AO56 2/HOLE MT	KELVINATOR	1/5		LBP/R-12	A	\$69.00
F9819	TL-56 3/HOLE MT.	WESTINGHOUSE	1/5		LBP/R-12	H	\$69.00

RANCO STYLE BEVERAGE WATER COOLER CONTROL TYPE WITH DIAL FACE PLATE AND KNOB

Type K50 Replaces type "A" controls. Complete with dial face plate and dial knob. Postive OFF position. Capillary 42" long, 2-1/8" mounting hole centers. Spade Push-Connections.

MDL# K50-P1125

CAT# A1979

COLD-OUT 0F
COLD-IN +15F
WARM-IN +47F

Price Ea: \$15.95



RANCO STYLE BEVERAGE WATER COOLER CONTROL TYPE WITH DIAL FACE PLATE AND KNOB

Type K50 Replaces type "A" controls. Complete with dial face plate and dial knob. Postive OFF position. Capillary 42" long, 2-1/8" mounting hole centers. Spade Push-Connections.

MDL# K50-P1126

CAT# A1980

COLD-OUT -12F
COLD-IN 0F
WARM-IN +15F

Price Ea: \$15.95



RANCO STYLE BEVERAGE WATER COOLER CONTROL TYPE WITH DIAL FACE PLATE AND KNOB

Type K50 Replaces type "A" controls. Complete with dial face plate and dial knob. Postive OFF position. Capillary 42" long, 2-1/8" mounting hole centers. Spade Push-Connections.

MDL# K50-P1127

CAT# A1981

COLD-OUT +35F
COLD-IN +41F
WARM-IN +54F

Price Ea: \$15.95



PACKARD 1/15 HP - 3.3" EVAPORATOR REPLACEMENT MOTOR - FOR HEATCRAFT-BOHN-CHANDLER-LARKIN-CLIMATE CONTROL.

Replacement for walk in cooler evaporator fans. Low amp draw motor. Low temperature lub system. Frame 3.3" UL Class B insulation -40 degrees celcius AMB. 1 Speed - 1500 RPM. 5/16" Shaft x 3" Long. CW rotation facing shaft.

CAT# 41126

PACKARD 1/15 HP 115V

Price Ea: \$79.00



CAT# 41124

PACKARD 1/15 HP 230V

Price Ea: \$79.00



G.E. CURRENT RELAY MDL# 3ARR2-KCP172S

1/2 HP - 3/4 HP
115V.

CAT.# A1CKCP172

Price Ea: \$14.95

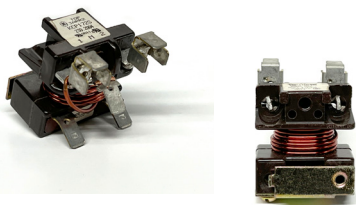

MOTOR RUN CAPACITOR MDL#

Round Body.
35 MFD X 440/370V.

CAT.# A1945

Price Ea: \$14.95



AIR COOLED REFRIGERATION CONDENSING UNITS

230V/60HZ/1PH

HIGH STARTING TORQUE FOR EXPANSION VALVE

Efficient smooth running units consists of a hermetic compressor condenser and motor assembly, mounted on heavy steel galvanized base. Complete with suction side service and liquid receiver tank and dual pressure control. (1 HP & 3/4 units have low pressure control) All starting components wired and mounted. Units available in 3-Phase. Call for 3-Phase prices.



CONDENSING UNITS FOR MEDIUM TEMP R-12 OR R-134A

CAT.#	HP	VOLTS/HZ/PH	REFRIGERANT	PRICE EA.
A1C55	3/4	115/60/1	R-12 / R-134A	\$1,295.00
A1C871	3/4	230/60/1	R-12 / R-134A	\$1,295.00
A1C903	1	230/60/1	R-12 / R-134A	\$1,495.00
A1C861	1-1/2	230/60/1	R-12 / R-134A	\$2,095.00
A1C862	2	230/60/1	R-12 / R-134A	\$2,295.00
A1C863	3	230/60/1	R-12 / R-134A	\$3,695.00

LOW TEMP REFRIGERANT R-404A UNITS

CAT.#	HP	VOLTS/HZ/PH	REFRIGERANT	PRICE EA.
A1C988	3/4	230/60/1	R-404A	\$1,295.00
A1C989	1	230/60/1	R-404A	\$1,495.00
A1C990	1-1/2	230/60/1	R-404A	\$2,295.00
A1C991	2	230/60/1	R-404A	\$2,495.00
A1C992	3	230/60/1	R-404A	\$3,695.00



MEDIUM TEMP REFRIGERANT R-22 OR 4-404A UNITS

CAT.#	HP	VOLTS/HZ/PH	REFRIGERANT	PRICE EA.
A1C1002	3/4	115/60/1	R-22 / R-404A	\$1,295.00
A1C902	3/4	230/60/1	R-22 / R-404A	\$1,295.00
A1C904	1	230/60/1	R-22 / R-404A	\$1,495.00
A1C905	1-1/2	230/60/1	R-22 / R-404A	\$2,095.00
A1C906	2	230/60/1	R-22 / R-404A	\$2,295.00
A1C907	3	230/60/1	R-22 / R-404A	\$3,395.00
A1C976	5	230/60/1	R-22 / R-404A	\$3,695.00
A1C977	5	230/60/3	R-22 / R-404A	\$3,695.00

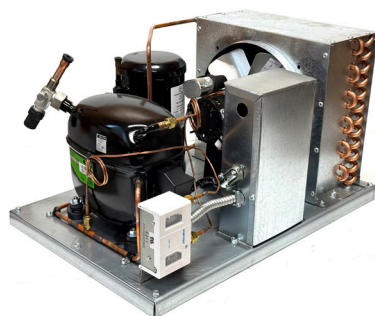

DANFOSS ELIMINATOR FILTER-DRIERS

CAT#	MFG#	CONN. SIZE	TYPE	HP	CU. IN	PRICE EA.
A10033	EK-0332	3/8" ODF	033-S	1/2	3	\$5.00
A1012	DML-1625S	5/16" ODF	162S	3/4 - 1.5	16	\$8.95
A1018	DML-305S	5/8" ODF	305S	5 - 7.5	30	\$22.00
A1019	DCL-305	5/8" SAE FL	305	5 - 7.5	30	\$22.00
A1020	DCL-417S	7/8" ODF	417S	7.5 - 10	41	\$25.00
A1015	67-9015	1/2" SAE FL	164	3 - 5	16	\$9.95
A1016	68-167S	7/8" ODF	167	3 - 4	16	\$9.95



SECOP 3/4 HP Medium Temperature Condensing Unit
115V/60HZ/1PH R-404A

Medium back pressure High Starting Torque for expansion valve. Complete with starting components, receiver tank, suction side service valve and low side pressure control.



CAT.# A1C1002

Price ea: \$1,295.00

1/2 HP Medium Temperature Condensing Unit
115V / 60HZ / 1PH R-134A

Medium back pressure R-134A High Starting Torque for expansion valve. Complete with starting components, receiver tank, suction side service valve.



CAT.# A1C54

Price ea: \$695.00

FRACTIONAL HP AIR COOLED CONDENSING UNITS

CAT.#	HP	VOLTS/HZ/PH	REFRIGERANT	Tank	PRICE EA.
A2U981	1/8	115/60/1	R-134A /LOW-MED/LST	NO	\$275.00
A1C981	1/5	115/60/1	R-134A /LOW-MED/LST	NO	\$295.00
A1U0022	1/5	115/60/1	R-404A/MEDIUM/LST	YES	\$325.00
A1C933	1/3	115/60/1	R-134A/MEDIUM/HST	YES	\$450.00
A1C938	1/3	115/60/1	R-404A/LOW-MED/HST	YES	\$450.00
A1U801	1/3	230/60/1	R-404A/LOW-MED/HST	YES	\$450.00
A1U802	1/3	230/60/1	R-134A/LOW-MED/HST	YES	\$395.00
A1U9427Z	1/3	115/60/1	R-404A/MEDIUM/HST	YES	\$595.00
A1U0440	1/2	115/60/1	R-404A/MEDIUM/HST	YES	\$595.00
A1C54	1/2	115/60/1	R-134A/MEDIUM/HST	YES	\$695.00
A1C54230	1/2	230/60/1	R-134A/MEDIUM/HST	YES	\$695.00



DANFOSS-SECOP COMPRESSOR
MDL# SC12CLX

LBP-2,000 BTU / HBP-7,600 BTU. HST for TXV or capillary tube with electrical and POE oil.

Model No. SC12CLX

CAT.# A1C12CLX230

HP: 1/2
Volts: 230V
Refrigerant: R-404A
Mount: 4" x 6.5"



Price Ea: \$295.00

DANFOSS-SECOP COMPRESSOR
MDL# NF7MLX

LBP-1,490 BTU / HBP-5,015 BTU. HST for TXV or capillary tube with electrical and POE oil.

Model No. NF7MLX

CAT.# A1C7MLX230

HP: 1/3
Volts: 230V
Refrigerant: R-404A
Mount: 4" x 6.5"



Price Ea: \$185.00

DANFOSS-SECOP COMPRESSOR
MDL# SC18CL

803-2741 BTU. 50 HZ. LBP-HST for TXV or capillary tube with electrical.

Model No. SC18CL

CAT.# A1C18CL
HP: 3/4
Volts: 220-240V - 50 HZ
Refrigerant: R-404A / R-507
Mount: 4" x 6.5"



Price Ea: \$400.00

DANFOSS-SECOP COMPRESSOR
MDL# SC12DL

3,838 BTU @ 20+F. 50 HZ. MBP/HBP for TXV or capillary tube with electrical.

Model No. SC12DL

CAT.# A1CSC12DL
HP: 1/2
Volts: 220-240V - 50 HZ
Refrigerant: R-404A / R-507
Mount: 4" x 6.5"



Price Ea: \$325.00

DANFOSS-SECOP COMPRESSOR
MDL# SC18GH

2,880 BTU @ 20+F. 50 HZ. MBP/HBP for TXV or capillary tube, comes with electrical.

Model No. SC18GH

CAT.# A1CSC18GH
HP: 1/2 HP
Volts: 220-240V - 50 HZ
Refrigerant: R-134A / R-513A
Mount: 4" x 6.5"



Price Ea: \$325.00

DANFOSS-SECOP COMPRESSOR
MDL# SC21F

50 HZ. LBP/MBP for TXV or capillary tube, comes with electrical.

Model No. SC21F

CAT.# A1CSC21F
HP: 1/2+
Volts: 220-240V - 50 HZ
Refrigerant: R-134A
Mount: 4" x 6.5"



Price Ea: \$395.00

<p>3/4 HP Air Cooled Condensing Unit - Medium Temp MDL# ZB07KAE-PFV - 230V / 1PH / 60HZ - R-404A</p> <p>7,000 BTU @20+F. Evap temperature. With Copeland scroll ZB07KAE-PFV. Medium Temp. LP Control and receiver tank</p> <p>Model No. ZB07KAE-PFV CAT.# A1C902 HP: 3/4 Volts: 230V / 60HZ / 1 PH Refrigerant: R-404A / R-22 Dimensions: 17"H x 15.25"W x 22"D</p> <p>Price Ea: \$1,295.00</p>	<p>1 HP Air Cooled Condensing Unit - Medium Temp MDL# ZB08KAE-PFV - 230V / 1PH / 60HZ - R-404A</p> <p>8,000 BTU @ 20+F. Evap temperature. With Copeland scroll ZB08KAE-PFV. LP Control and receiver tank - 17"H x 19-1/4"W x 23"D</p> <p>Model No. ZB08KAE-PFV CAT.# A1C904 HP: 1 Volts: 230V / 60HZ / 1 PH Refrigerant: R-404A / R-22 Demensions: 17"H x 19.25"W x 23"D</p> <p>Price Ea: \$1,495.00</p>
--	---



<p>1/2 HP Air Cooled Condensing Unit - Medium Temp MDL# M2FH0056-IAV - 208-230V / 1PH / 60HZ - R-134A</p> <p>4,140 BTU @ 20+F. Medium Temp. High torque unit with reciever tank, high and low side valves. <i>Copeland model: ART64C1E</i></p> <p>Model No. M2FH0056-IAV CAT.# A1U0056-2 HP: 1/2 Volts: 230V / 60HZ / 1 PH LRA: 30.0 Refrigerant: R-134A</p> <p>Price Ea: \$695.00</p>	<p>1/3 HP Air Cooled Condensing Unit - Medium Temp CAT.# A1C933 - 115V / 1PH / 60HZ - R-134A</p> <p>4,000 BTU. High starting torque air cooled condensing unit for expansion valve or capillary tube application. Unit complete with liquid reciever tank, high side and low side service valves and all electrical starting components.</p> <p>Model: NF11FX CAT.# A1C933 HP: 1/3 Volts: 115V / 60HZ / 1 PH Refrigerant: R-134A</p> <p>Price Ea: \$450.00</p>
---	--



<p>1/2 HP Air Cooled Condensing Unit - MBP/LBP Temp MDL# USC12MLX - 115V / 1PH / 60HZ - R-404A</p> <p>2,200 BTU @ -10F. Low / Medium temperature. High torque for expansion valve or capillary tube with receiver tank, 1/4" High side and 1/2" Low side valves.</p> <p>Model: USC12MLX CAT.# A1U12MLX HP: 1/2 Volts: 115V / 60HZ / 1 PH Refrigerant: R-404A</p> <p>Price Ea: \$695.00</p>	<p>3/4 HP SECOP Air Cooled Condensing Unit - Medium Temp MDL# SC18MLX - 115V / 1PH / 60HZ - R-404A</p> <p>Medium back pressure. High starting torque for expansion valve. Complete with starting components, receiver tank, suction side service valve and low side pressure control.</p> <p>Model: SC18MLX CAT.# A1C1002 HP: 3/4 Volts: 115V / 60HZ / 1 PH Refrigerant: R-404A</p> <p>Price Ea: \$1,295.00</p>
--	---

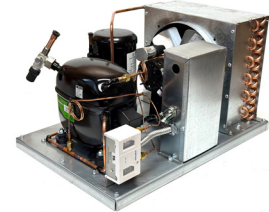





WATER COOLED COMMERCIAL CONDENSING UNITS

COMPLETE WATER COOLED CONDENSING UNITS. COMPRESSOR WITH COOLED CONDENSER, WATER VALVE, RECEIVER TANK, HI-LOW PRESSURE CONTROL, SERVICE VALVES AND ELECTRICAL STARTING COMPONENTS.

CAT.#	HP	REFRIGERANT	PRICE EA.
A1C982	1	R-134A / R-12	CALL FOR PRICES
A1C983	2	R-134A / R-12	CALL FOR PRICES
A1C984	3	R-134A / R-12	CALL FOR PRICES
A1C895	1	R-22 / R-404A	CALL FOR PRICES
A1C896	2	R-22 / R-404A	CALL FOR PRICES
A1C897	3	R-22 / R-404A	CALL FOR PRICES



<p>SECOP 1/2 HP Air Cooled Condensing Unit - Low-Med Temp MDL# USC12CLX - 115V / 1PH / 60HZ - R-404A</p> <p>2,000 BTU @-10F. Low-Medium back pressure. High starting torque with receiver tank, suction and liquid service valves.</p> <p>Model No. USC12CLX CAT.# A1USC12CLX HP: 1/2 Volts: 115V / 60HZ / 1 PH Refrigerant: R-404A Dimensions: 18"D x 13.25"W x 11"H</p> <p>Price Ea: \$695.00</p> 	<p>COPELAND 3/4 HP Air Cooled Condensing Unit - Med Temp 230V / 60 HZ / 1 PH - R-134A</p> <p>Medium temperature. Unit with Low pressure control with receiver tank. 19.25"W x 23.25"D x 16.5"H. FL SUCTION-3/8" FL LIQUID.</p> <p>Model: ZS09KAE-PFV CAT.# A1C871 HP: 3/4 Volts: 230V / 60HZ / 1 PH Refrigerant: R-134A</p> <p>Price Ea: \$1,295.00</p> 
--	--

<p>SECOP 1/2 HP Air Cooled Condensing Unit - Medium Temp MDL# USC18G - 115V / 1PH / 60HZ - R-404A</p> <p>6,000 BTU @45°F. Medium Temperature. High starting torque with receiver tank, suction and liquid service valves.</p> <p>Model No. USC18G CAT.# A1C54 HP: 1/2 Volts: 115V / 60HZ / 1 PH Refrigerant: R-404A Dimensions: 18"D x 13.25"W x 11"H</p> <p>Price Ea: \$695.00</p> 	<p>SECOP 1/3 HP Air Cooled Condensing Unit - Medium Temp MDL# UNF7CLX - 115V / 1PH / 60HZ - R-404A</p> <p>Medium back pressure. High starting torque with receiver tank, suction and liquid service valves. POE oil charge.</p> <p>Model No. UNF7CLX CAT.# A1UNF7CLX HP: 1/3 Volts: 115V / 60HZ / 1 PH Refrigerant: R-404A</p> <p>Price Ea: \$450.00</p> 
--	---



AIR COOLED CONDENSING UNITS - Medium Temp
HIGH STARTING TORQUE - 230V / 1PH / 60HZ - R-404A / R-22

Scroll condensing units. High starting torque with low side and high side service valves, receiver tank and all starting components mounted and wired. Comes with low side pressure control.

CAT.#	MODEL	HP	REFRIGERANT	PRICE EA.
A1UZB07	ZB07KAE-PFV	+3/4	R-22 / R-404A	\$1,295.00
A1UZB08	ZB08KAE-PFV	1	R-22 / R-404A	\$1,495.00
A1UZB13*	ZB13KCE-PFV	1-1/2	R-22 / R-404A	\$2,095.00
A1UZB15*	ZB15KCE-PFV	2	R-22 / R-404A	\$2,295.00

*** WITH DUAL PRESSURE CONTROL**



<p>SAMSUNG 2.5 HP Rotary Compressor - Low Temp MDL# UG5A290INZJ2 - 208-230V / 1PH / 60HZ - R-410A</p> <p>29,000 BTU. Low temperature. 6" triangle mount. With POE oil and cover. Can replace any scroll, piston or rotary compressor. 2-1/2 ton R-410A In A/C system used by CARRIER-NORTEK-GOODMAN.</p> <p>Model No. UG5A290INZJ2 CAT.# A2C290 HP: 2.5 Volts: 208-230V / 60HZ / 1 PH Refrigerant: R-410A Mount: 17"H</p> <p>Price Ea: \$190.00</p> 	<p>SAMSUNG 3.5 HP Rotary Compressor - Low Temp MDL# 5JD420XAC22 - 280V DC - R-410A</p> <p>42,000 BTU @ 45°F. For inverter style mini-split A/C systems. Comes with cover, rubber feet and POE oil charge.</p> <p>Model No. 5JD420XAC22 CAT.# A2C5JD42 HP: 3.5 Volts: 280V DC Refrigerant: R-410A Square Mount: 7.5" x 7.5"</p> <p>Price Ea: \$295.00</p> 
--	---

<p>SAGINO MIYA Dual Pressure Control with Capillary Tubes</p> <p>All range commercial dual pressure control. Low side pressure range 10" Vac. to 100 PSI. High pressure side 150 PSI to 450 PSI. With two 36" capillary tubes with 1/4" flare nuts.</p> <p>Model No. DNS-C2D306YQ12 CAT.# A1731</p> <p>Price Ea: \$130.00</p> 	<p>SAGINO MIYA Dual Pressure Control</p> <p>All range commercial dual pressure control. Low side pressure range 10" Vac. to 100 PSI. High pressure side 150 PSI to 450 PSI.</p> <p>Model No. DNS-C2D306YQ12 CAT.# A1731</p> <p>Price Ea: \$110.00</p> 
--	--

<p>1/5 HP Condensing Unit - R-134A - High Back Pressure 115V / 60HZ / 1 PH - R-134A</p> <p>High back pressure condensing unit for refrigerators, salad bars, water coolers, cold tables, etc.</p> <p>CAT.# A1C981</p> <p>HP: 1/5 Volts: 115V / 60HZ / 1 PH Refrigerant: R-134A <i>High Back Pressure. Capillary Tube.</i></p> <p>Price Ea: \$295.00</p> 	<p>1/8 HP Condensing Unit - R-134A - High Back Pressure 115V / 60HZ / 1 PH - R-134A</p> <p>High back pressure condensing unit for refrigerators, salad bars, water coolers, cold tables, etc.</p> <p>CAT.# A2U981</p> <p>HP: 1/8 Volts: 115V / 60HZ / 1 PH Refrigerant: R-134A <i>High Back Pressure. Capillary Tube.</i></p> <p>Price Ea: \$275.00</p> 
<p>1/2 HP Air Cooled Condensing Unit MDL# -230V / 60HZ / 1 PH - R-404A</p> <p><i>Low Temp - 2,000 BTU @ -10F. Medium Temp - 5,100 BTU @ 25+F.</i> Hermetic condensing unit, high starting torque with low side and high side service valves, receiver tank, and all starting components mounted and wired.</p> <p>Model No. CAT.# A1U12CLX</p> <p>HP: 1/2 Volts: 230V / 60HZ / 1 PH Refrigerant: R-404A Dimensions: 18"D x 13.25"W x 11"W</p> <p>Price Ea: \$695.00</p> 	<p>TECUMSEH +1/3 HP Air Cooled Condensing Unit - Medium Temp MDL# AKA9427ZXA - 115V / 60HZ / 1 PH - R-404A / R-22</p> <p>Medium Temperature. High starting torque with receiver tank, suction and liquid service valves.</p> <p>Model No. AKA9427ZXA CAT.# A1U9427ZA</p> <p>HP: +1/3 Volts: 115V / 60HZ / 1 PH Refrigerant: R-404A / R-22</p> <p>Price Ea: \$595.00</p> 
<p>COPELAND 1/5 HP Air Cooled Condensing Unit - Medium Temp MDL# M4PH-0022-IAA - 115V / 60HZ / 1 PH - R-404A</p> <p>Medium Temperature. High starting torque.. Condensate drain pan base. <i>No receiver tank.</i></p> <p>Model No. M4PH-0022-IAA CAT.# A1U0022</p> <p>HP: 1/5 Volts: 115V / 60HZ / 1 PH Refrigerant: R-404A</p> <p>Price Ea: \$325.00</p> 	<p>TECUMSEH 1/2 HP Air Cooled Condensing Unit MDL# AKA2425ZXA - 115V / 60HZ / 1 PH - R-404A</p> <p><i>2,500 BTU @ -10 F.</i> Low Temperature. All O.D. sweat connections. No tank.</p> <p>Model No. AKA2425ZXA CAT.# A1C2425ZA</p> <p>HP: 1/2 Volts: 115V / 60HZ / 1 PH Refrigerant: R-404A</p> <p>Price Ea: \$695.00</p> 
<p>TECUMSEH 1/2 HP Air Cooled Condensing Unit MDL# AEX433U-AA3CCK - 115V / 60HZ / 1 PH - R-290A</p> <p><i>BTU @ -10 F.</i> Low Temperature. All O.D. sweat connections. No tank.</p> <p>Model No. AEX433U-AA3CCK CAT.#</p> <p>HP: 1/2 Volts: 115V / 60HZ / 1 PH Refrigerant: R-290A</p> <p>Price Ea: \$750.00</p> 	<p>TECUMSEH 1/3 HP Air Cooled Condensing Unit MDL# TCX413U-AA1BCK - 115V / 60HZ / 1 PH - R-290A</p> <p>High starting torque with receiver tank, suction and liquid service valves.</p> <p>Model No. TCX413U-AA1BCK CAT.#</p> <p>HP: 1/3 Volts: 115V / 60HZ / 1 PH Refrigerant: R-290A</p> <p>Price Ea: \$650.00</p> 
<p>TECUMSEH 1/2 HP Low Profile Condensing Unit - Med/High Temp MDL# HGA0440EXA</p> <p>Rotary commercial unit. Medium/High temperature. High torque for TX valve or capillary tube application. Dimension: 28"W x 9-1/2"H x 18"D.</p> <p>Model No. HGA0440EXA CAT.# A1U0440</p> <p>HP: 1/2 Volts: 115V / 60HZ / 1 PH Refrigerant: R-404A / R-22</p> <p>Price Ea: \$395.00</p> 	<p>COPELAND 1/3 HP Condensing Unit - Medium Temperature MDL# ASE24C5E-IAA-201 - R-404A</p> <p><i>2,400 BTU @ +20F.</i> Medium temperature. High starting torque, suction and liquid service valves.</p> <p>Model: ASE24C5E-IAA-201 CAT.# A1C24C5E</p> <p>HP: 1/3 Volts: 115V / 60HZ / 1 PH Refrigerant: R-404A</p> <p>Price Ea: \$450.00</p> 

Totally Enclosed Condenser Fan Unit Bearing Motors

16 Watt - 50 Watt / 1550 RPM / 230V - 60HZ - 1 PH



CAT#	WATTS	ROTATION	SHAFT DIMENSIONS	PRICE EA.
28821	16	Clock Wise	1-4" x 20 Thread	\$65.00
28021	35	Clock Wise	1-4" x 20 Thread	\$119.00
28041	50	Clock Wise	3/8" x 1-1/2" Long	\$135.00

Totally Enclosed Condenser Fan Unit Bearing Motors

2 Watt - 50 Watt / 1550 RPM / 115V - 60HZ - 1 PH



CAT#	WATTS	ROTATION	SHAFT DIMENSIONS	PRICE EA.
28109	2	Clock Wise	1-4" x 20 Thread	\$35.00
28411	9	Clock Wise	1-4" x 20 Thread	\$48.00
28811	16	Clock Wise	1-4" x 20 Thread	\$65.00
28020	35	Clock Wise	1-4" x 20 Thread	\$119.00
28040	50	Clock Wise	3/8" x 1-1/2" Long	\$135.00

MORILL 6 CW Watt Unit Bearing Condenser Motor

230V / 1 PH / 60 HZ - 1,500 RPM

Cat# F3255

1/4" threaded shaft. 3 hole back mount or 4 hole top and bottom mount. For up to 9" hubless fan blade.

Model: Morill
RPM: 1,500
Volts: 230V
Shaft Length: 1/4" threaded



Price Ea: \$12.95

MORILL 16 CW Watt Unit Bearing Condenser Motor

230V / 1 PH / 60 HZ - 1,500 RPM

Cat# F5416W

Cast iron body. 1/4" threaded shaft. 3 hole back mount or 4 hole top and bottom mount. For up to 10" hubless fan blade.

Model: Morill
RPM: 1,500
Volts: 230V
Shaft Length: 1/4" threaded



Price Ea: \$25.00

NECCHI 1/3 HP Universal Compressor

MDL# ESM11K - 115V / 60 HZ / 1 PH - R-134A

1,200 BTU @ -10 deg. F. Necchi universal compressor with oil cooler lines. Low temperature. For refrigeration up to 24 cubic feet. 8" high. Mounting holes 4" x 6.5". Capillary tube application.

Model No. ESM11K

Cat# G101
Model: Necchi
HP: 1/3
Volts: 115V
Refrigerant: R-134A



R-134A

Price Ea: \$125.00

NECCHI 1/3 HP Universal Compressor

MDL# ESM11K - 115V / 60 HZ / 1 PH - R-12

1,200 BTU @ -10 deg. F. Low temperature. For refrigeration up to 24 cubic feet. 8" high. Mounting holes 4" x 6.5". Capillary tube application.

Model No. ESM11K

Cat# G100
Model: Necchi
HP: 1/3
Volts: 115V
Refrigerant: R-12



R-12

Price Ea: \$99.00

Reach-In Unit - Slope Front Evaporator for 1/2 HP 115V Commercial Temp Unit MDL# SF-175

Unit coolers are ideal for refrigerated reach-ins. Mounts to top of refrigerator and discharges cold air against back wall.

Model: SF-175

CAT.# F78SF175

HP: 1/2

Volts: 115V



Price Ea: \$295.00

PACKARD 1/6 HP Condenser Fan Motor MDL# 40265 - 208-230V

1,550 RPM. Totally enclosed body. Reversible rotation. All angle mounting. With mounted run cap.

Model No. 40265

Cat# A1M40265

Model: Packard
HP: 1/6
Volts: 208-230V
Shaft Dia: 1/2"
Shaft Length: 6"



Price Ea: \$135.00

A.O. SMITH 1/4 HP Condenser Fan Motor 208-230V

1,075 RPM. Totally enclosed body. Reversible rotation. All angle mounting. PSC motor capacitor required.

Capacitor Extra. 5 MFD x 370V - \$2.95

Model No. F48Y32D75

Cat# FE1026SB
Model: A.O. Smith
HP: 1/4
Volts: 208-230V
Shaft Dia: 1/2"
Shaft Length: 6"

Body Dia: 5-5/8"



Price Ea: \$125.00

MAGNETEK Flue Exhaust & Draft Booster Blower - 208/230V 60HZ

Ball bearing motor. 4" intake. 2-1/4" exhaust.

Model No. JB1C049NSV

Cat# F11797

Model: MAGNETEK
HP: 1/40 HP
RPM: 3,000
Volts: 230V / 1 PH / 60 HZ



Price Ea: \$42.00

EMERSON 1/2 HP Evaporator Motor 208-230V - 48 Frame

1,075 RPM. 2 Speed. CW shaft end. Run capacitor Extra. 7.5 MFD x 370V - \$3.95

Model No. K55HXHTC-8866

Cat# F338866
Model: Emerson
HP: 1/2
Volts: 208-230V
Shaft Dia: 1/2"
Shaft Length: 2.75"



Price Ea: \$59.00

G.E. Evaporator Direct Drive Fan & Blower Motor - 230V - 48 Frame

1,075 RPM. 3 Speed. CW facing shaft end. Run capacitor.

Model No. 5KCP39RGU052S

Cat# F90052S
Model: G.E.
CPN: HC52AE209
HP: 1
Volts: 230V / 1 PH / 60 HZ
Shaft Dia:
Shaft Length: 4.5"

Body Dia: 5-5/8"



Price Ea: 149.00

Johnson Controls Air Handler-Evaporator for 10 and 12 SEER Air Conditioning Units R-22 or R-410A

Insulated cabinet to control sound and condensation-direct drive multi-speed motor. Built-in "A" coil-Horizontal and Vertical drain pans with secondary drains. Can be located in a closet, utility room, crawl space or basement. Blower motor 230/60/1. For R-22 or R-410A gas.

Model No. 4 TON 48D

CAT.# A1B48D

Heating Element & Fixed Orifice Metering Device not included.

When ordering specify refrigerant for R-22 or R-410A

48D - 48,000 BTU
Dimensions: 57"H x 24.5"W x 22"D

Price Ea: \$400.00



Klixon Defrost Termination Switches

CAT#	Model No.	Klixon No.	Temp. Setting	Price Ea.
80605	ML45	S2064RL45	Open 45+ deg F.	\$9.95
80606	ML50	S2064RL50	Open 50+ deg F.	\$9.95
80607	ML55	S2064RL55	Open 55+ deg F.	\$9.95
80608	ML60	S2064RL60	Open 60+ deg F.	\$9.95
80609	ML70	S2064RL70	Open 70+ deg F.	\$9.95



J/B Black Gold - Vacuum Pump Oil

This high quality extremely low vapor pressure mineral oil is especially formulated for use in deep vacuum mechanical pumps.

The superior quality of this oil gives the extra edge in pumping speed when your pump is working under deep vacuum.

Model No. DVO-12
[1 Quart bottle]

Cat# 4587



Price Ea: \$17.00

Model No. DVO-1
[1 Pint bottle]

Cat# 45870



Price Ea: \$12.00

Model No. DVO-24
[Gallon bottle]

Cat# 4501



Price Ea: \$52.00

RBM Relay SPST 24V Coil

1 HP 125V/ 2 HP 230V - 18 LRA. Used to control blower motors in furnace and air conditioners. Fit 1/2" hole in all type of electrical boxes.



Model: 129515-3180ZL



CAT.# F98824



Price Ea: \$30.00



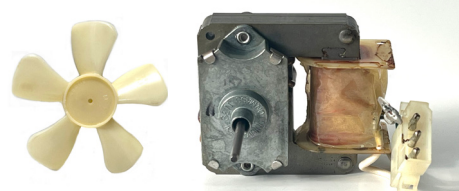

<p>G.E. PSC 1/3 HP Fan & Blower Motor MDL# 5KCP39HGY143S - 230V</p> <p><i>3/SPEED: 1,075/950/800 RPM.</i> CCW rotation facing shaft. 48 Frame. <i>Carrier# 1081398</i> <i>Run Capacitor Extra: 7.5 MFD x 370V - \$3.95</i></p>	<p>G.E. 1/8 HP Condenser Motor MDL# 5KCP39GFY084S - 230V</p> <p><i>800 RPM.</i> Totally enclosed body. CCW rotation facing shaft. 48 Frame. <i>Carrier# H36GE238A</i></p>	<p>EBM Pabst Tangential Fan Blower Motor MDL# QLZ06 0018 - 240V</p> <p><i>1,075 RPM.</i> Tangential fan blower motor. 36 Watt. 7-1/2" Width.</p>
<p>Model No. 5KCP39HGY143S</p> <p>Cat# F90143S Model: G.E. HP: 1/3 Volts: 230V / 60HZ / 1PH Shaft Dia: 1/2" Shaft Length: 5" Belly Band Mount</p> <p>Price Ea: \$39.00</p> 	<p>Model No. 5KCP39GFY084S</p> <p>Cat# F90084S Model: G.E. HP: 1/8 Volts: 230V / 60HZ / 1PH Shaft Dia: 1/2" Shaft Length: 3" Belly Band Mount or end bolt.</p> <p>Price Ea: \$129.00</p> 	<p>Model No. QLZ06-0018</p> <p>Cat# F90QLZ0618 Model: EBM Pabst HP: 1/2 Volts: 240V / 50-60HZ / 1PH</p> <p>Price Ea: \$49.00</p> 
<p>G.E. 1/2 HP Fan & Blower Motor MDL# 5KCP39MGT382S - 208-230V</p> <p><i>3/SPEED: 1,075 RPM.</i> CW rotation facing shaft. 48 Frame. <i>Run Capacitor Extra: 7.5 MFD x 370V - \$3.95</i></p>	<p>G.E. PSC 1/3 HP Fan & Blower Motor MDL# 5KCP39EGAA98 - 208-230V</p> <p><i>1/SPD: 1,050 RPM.</i> CW rotation facing shaft. 48 Frame.</p>	<p>EBM Pabst Tangential Fan Blower Motor MDL# QLZ06 0024 - 120V</p> <p><i>1,075 RPM.</i> Tangential fan blower motor. 36 Watt. 7-1/2" Width.</p>
<p>Model No. 5KCP39MGT382S</p> <p>Cat# F90382S Model: G.E. HP: 1/2 Volts: 208-230V / 60HZ / 1PH Shaft Dia: 1/2" Shaft Length: 4" Belly Band Mount</p> <p>Price Ea: \$59.00</p> 	<p>Model No. 5KCP39EGAA98</p> <p>Cat# F90GAA98 Model: G.E. HP: 1/3 Volts: 208-230V Shaft Dia: 1/2" Shaft Length: 4-1/2" Belly Band Mount</p> <p>Price Ea: \$59.00</p> 	<p>Model No. QLZ06-0024</p> <p>Cat# F90QLZ0624 Model: EBM Pabst HP: 1/2 Volts: 120V / 50-60HZ / 1PH</p> <p>Price Ea: \$69.00</p> 
<p>MAGNETEK UNIVERSAL PSC 3/4 HP Fan & Blower Motor MDL# HE3T015N - 115V</p> <p><i>4/SPEED: 1,000/950/850/800 RPM.</i> CCW rotation facing shaft. 5-5/8" Body Diameter. 48 Frame. <i>Carrier# 1081398</i> <i>Run Capacitor Extra: \$4.25</i></p>	<p>G.E. PSC 1/8 HP Condenser Motor MDL# 5KCP39GFY689S - 460V</p> <p><i>1/SPEED: 825 RPM.</i> CCW rotation facing shaft. 5-5/8" Body Diameter. 48 Frame. <i>CPN# HC35GE465</i></p>	<p>G.E. PSC 1 HP Fan & Blower Motor MDL# 5KCP39RGU052S - 230V</p> <p><i>3/SPEED: 1,075/950/800 RPM.</i> CW rotation facing shaft. 48 Frame. <i>Carrier# HC52AE209</i> <i>Run Capacitor Extra: 7.5 MFD x 370V - \$3.95</i></p>
<p>Model No. HE3T015N</p> <p>Cat# F1115 Model: Magnetek HP: 3/4 Volts: 115V / 60HZ / 1PH Shaft Dia: 1/2" Shaft Length: 3" Belly Band Mount</p> <p>Price Ea: \$39.95</p> 	<p>Model No. 5KCP39GFY689S</p> <p>Cat# F90Y689S Model: G.E. HP: 1/8 Volts: 460V / 60HZ / 1PH Shaft Dia: 1/2" Shaft Length: 2"</p> <p>Price Ea: \$99.00</p> 	<p>Model No. 5KCP39RGU052S</p> <p>Cat# F90052S Model: G.E. HP: 1 Volts: 230V / 60HZ / 1PH Shaft Dia: 1/2" Shaft Length: 4" Belly Band Mount</p> <p>Price Ea: \$199.00</p> 
<p>G.E. PSC 1/8 HP Condenser Motor MDL# 5KCP39HFY536S - 575V</p> <p><i>1/SPEED: 810 RPM</i> <i>CPN# HC35GE577</i> <i>Run Capacitor Extra: 5MFD x 370V \$2.95</i></p>	<p>MAGNETEK 1/15 HP PSC Evaporator Fan Motor MDL# JE2F026N - 115V</p> <p><i>2/SPEED: 1,230/950 RPM.</i> 2 Shafts. Cut shaft. CW or CCW. Body diameter: 3-1/2". <i>Run Capacitor Extra: 7.5 MFD x 370V - \$3.95</i></p>	<p>McMILLAN 1/20 HP Ball Bearing Split Motor MDL# 8224315020 - 120V</p> <p><i>3/SPEED: 1,500/1,300/1,000 RPM.</i> CW rotation facing shaft. 4 bolt front and bottom mount to replace unit bearing type motors.</p>
<p>Model No. 5KCP39HFY536S</p> <p>Cat# F90536S HP: 1/8 Volts: 575V / 60HZ / 1PH Shaft Dia: 1/2" Shaft Length: 1-3/4"</p> <p>Price Ea: 89.00</p> 	<p>Model No. JE2F026N</p> <p>Cat# F2JE2F Model: Magnetek HP: 1/15 Volts: 115V / 60HZ / 1PH 2/Shafts Dia: 5/16" 2/Shafts Length: 1-1/2" x 1-1/2" Belly Band Mount</p> <p>Price Ea: \$16.95</p> 	<p>Model No. 8224315020</p> <p>Cat# F20822 Model: McMillan HP: 1/20 Volts: 230V / 60HZ / 1PH Shaft Dia: 5/16" Shaft Length: 1-5/8"</p> <p>Price Ea: \$24.00</p> 

<p>INTER LINK PSC Blower / Fan Motor MDL# YSLB-750-6-B001 - 115V</p> <p>1,075 RPM. 4 Speed. Totally enclosed body. Reversible rotation. Rotation CCW lead end.</p> <p>Model No. YSLB-750-6-B001 Cat# F903949 HP: 1 Volts: 115V / 60HZ / 1PH Shaft Dia: 5/8" Shaft Length: 4" Belly Band Mount Body Dia: 5-5/8"</p> <p>Price Ea: \$45.00</p> 	<p>MURATA Push-On Solid State PTC Relay for Refrigeration Compressors - 115V</p> <p>3 Terminals Relay with run capacitor connection. 1/3 HP. PTHAS-T 4R7M180 / PTH4900-AS4R7</p> <p>Model No. PTH490D Cat# F1920 HP: 1/20 -1/3 Volts: 115</p> <p>Price Ea: \$12.00</p> 	<p>EMERSON 1/2 HP Blower Motor MDL# K55HXHTC-8866 - 230V / 60HZ / 1 PH</p> <p>1,075 RPM. 2 Speed. 5-5/8" body diameter. Rotation CW lead end.</p> <p>Model No. K55HXHTC-8866 Cat# A1M8866 HP: 1/2 HP Volts: 208-230V Shaft Dia: 1/2"</p> <p>Price Ea: \$50.00</p> 
--	---	--

<p>Frigid-Air Domestic Evaporator Fan Motor Kit 115V / 60HZ</p> <p>Replacement evaporator motor for: Admiral-Amana-Coldspot-Frigidaire-General Electric-Hot Point-Westinghouse-Norge-Whirlpool. Heavy duty fan motor, oversized oil reservoir.</p> <p>Cat# A1M1733</p> <p>Volts: 115V Shaft Dia: 1/8" Shaft Length: 1-1/4" Rotation: CW Facing Shaft</p> <p>Fan Blade Included Rubber Tip Hang Mounts.</p> <p>Price Ea: \$14.95</p> 	<p>EMERSON 1/5 HP Blower Motor MDL# K55HXHSL-8851 - 230V / 60HZ / 1 PH</p> <p>1,075 RPM. 2 Speed. 5-5/8" body diameter. Rotation CW lead end. Free 5 MFD x 370V Run Capacitor.</p> <p>Model No. K55HXHSL-8851 Cat# A1M8851 HP: 1/5 HP Volts: 208-230V Shaft Dia: 1/2"</p> <p>Price Ea: \$24.95</p> 
---	---

<p>Klixon Relays - Push-On Type for Refrigeration Compressors - 115V</p> <p>Low back pressure compressors. No capacitor connection.</p> <table border="1"> <thead> <tr> <th>Cat#</th> <th>Part No.</th> <th>H.P.</th> </tr> </thead> <tbody> <tr> <td>A1E119</td> <td>PR18</td> <td>1/8</td> </tr> <tr> <td>A1E120</td> <td>PR16</td> <td>1/6</td> </tr> <tr> <td>A1E121</td> <td>PR15</td> <td>1/5</td> </tr> <tr> <td>A1E122</td> <td>PR14</td> <td>1/4</td> </tr> <tr> <td>A1E123</td> <td>PR13</td> <td>1/3</td> </tr> </tbody> </table> <p>Price Ea: \$5.95</p> 	Cat#	Part No.	H.P.	A1E119	PR18	1/8	A1E120	PR16	1/6	A1E121	PR15	1/5	A1E122	PR14	1/4	A1E123	PR13	1/3	<p>Klixon Overload Protectors - Push-On Type for Refrigeration Compressors - 115V</p> <p>Type MRA 3/4" Overload protectors for refrigeration compressors.</p> <table border="1"> <thead> <tr> <th>Cat#</th> <th>Part No.</th> <th>H.P.</th> </tr> </thead> <tbody> <tr> <td>A1E200</td> <td>018P</td> <td>1/8</td> </tr> <tr> <td>A1E201</td> <td>016P</td> <td>1/6</td> </tr> <tr> <td>A1E202</td> <td>015P</td> <td>1/5</td> </tr> <tr> <td>A1E203</td> <td>014P</td> <td>1/4</td> </tr> <tr> <td>A1E204</td> <td>013P</td> <td>1/3</td> </tr> </tbody> </table> <p>Price Ea: \$5.95</p> 	Cat#	Part No.	H.P.	A1E200	018P	1/8	A1E201	016P	1/6	A1E202	015P	1/5	A1E203	014P	1/4	A1E204	013P	1/3	<p>Domestic-Commercial Compressor Relay & Overload Kits - 115V</p> <p>For low starting torque compressors. Overload and Relay Kit. No capacitor.</p> <table border="1"> <thead> <tr> <th>Cat#</th> <th>Part No.</th> <th>H.P.</th> </tr> </thead> <tbody> <tr> <td>A118</td> <td>018P</td> <td>1/8</td> </tr> <tr> <td>A116</td> <td>016P</td> <td>1/6</td> </tr> <tr> <td>A115</td> <td>015P</td> <td>1/5</td> </tr> <tr> <td>A114</td> <td>014P</td> <td>1/4</td> </tr> <tr> <td>A113</td> <td>013P</td> <td>1/3</td> </tr> </tbody> </table> <p>Price Ea: \$8.95</p> 	Cat#	Part No.	H.P.	A118	018P	1/8	A116	016P	1/6	A115	015P	1/5	A114	014P	1/4	A113	013P	1/3
Cat#	Part No.	H.P.																																																						
A1E119	PR18	1/8																																																						
A1E120	PR16	1/6																																																						
A1E121	PR15	1/5																																																						
A1E122	PR14	1/4																																																						
A1E123	PR13	1/3																																																						
Cat#	Part No.	H.P.																																																						
A1E200	018P	1/8																																																						
A1E201	016P	1/6																																																						
A1E202	015P	1/5																																																						
A1E203	014P	1/4																																																						
A1E204	013P	1/3																																																						
Cat#	Part No.	H.P.																																																						
A118	018P	1/8																																																						
A116	016P	1/6																																																						
A115	015P	1/5																																																						
A114	014P	1/4																																																						
A113	013P	1/3																																																						

<p>Klixon Push-On Current Relay for Refrigeration Compressors - 115V</p> <p>1/3 HP. 3 Terminals with start capacitor connections.</p> <p>Model No. 966OC-3018-18216 CAT# F19182</p> <p>Price Ea: \$14.95</p> 	<p>G.E. Current Relay- Push-On Terminals Model No. 3ARR12-PL22 - 115V</p> <p>1/3 HP. 115V with capacitor connection. Push-on terminals. For models: AEA1413YXA-AXA / AEA3440YXA-AXA / AEA4440YXA-AXA and similar Aspera and Copeland compressors.</p> <p>Model No. 3ARR12-PL22 CAT# F5413</p> <p>Tecumseh No. P82929</p> <p>Price Ea: \$6.95</p> 	<p>G.E. Current Relay Screw-On Terminals Model No. 3ARR12-KPM71 - 115V</p> <p>1/3 HP - 1/4 HP. 115V. With capacitor connection. For models: AEA2410YXA-AXA / AEA24112XA / AEA2415AXA / AEA2416JXA / AEA4448YXA-AXA / AEA2413YXA-AXA / AEA9422EXA-ZXA and similar Aspera and Copeland compressors. Screw-on terminals.</p> <p>Model No. 3ARR12-KPM71 CAT# F5412</p> <p>Tecumseh No. P82473</p> <p>Price Ea: \$6.95</p> 
---	--	--

<p>Domestic Charging Valve Dryer</p> <p>1/3 Ton copper filter dryer. 1/4" OD Inlet & Outlet with 1/4" SAWE access valve.</p> <p>Model No. 619 CAT.# 7531</p> <p>Price Ea: \$9.95</p> 	<p>Domestic Molecular Sieve Liquid Line Dryer</p> <p>Copper spun end dryer with sealed 1/4" OD tube extensions, filter/dryer for up to 1/3 Ton domestic refrigerators.</p> <p>Model No. CAT.# 20040</p> <p>Price Ea: \$3.95</p> 
---	--

J/B Charging & Testing 2-Valve Classic Brass Manifold
R-134a ,R-22 and R-404a Scales

Model No. M2-21131

Cat# 45X21

Complete with 3 color coded 60" hoses. Easy to read dial. Handy built-in hook. Forged brass body. "O" ring pistons eliminates leaks. "Flutter" free lexan gauges.



Price Ea: \$165.00

J/B 2-Valve Classic Brass Manifold with KOBRA Hoses
R-404a ,R-410A and R-22

Model No. M2-5-410A

Cat# 45X21

Complete with 3 color coded 60" B-R-Y KOBRA High-Pressure hose. 4,000 PSI. 1/4" full flow charging and testing manifold. Hi-Low pressure gauges. Handy built-in hook. Forged brass body. "Flutter" free lexan gauges.



Price Ea: \$165.00

J/B Refrigeration Manifold Gauges - 2.5"
High Pressure: RED

Model No. M2-435

Cat# 45X61

HIGH PRESSURE: RED - High side pressure from 0 to 500 lbs. Temperature scale for R-134a, R-22, R-404a. 1/8" MPT. 2-1/2" dial face. Full size brass movement. Pointer flutter dampened. Surge dampened. Recalibration screw. High impact Lexan lens.



Price Ea: \$21.50

J/B Refrigeration Manifold Gauges - 2.5"
High Pressure: BLUE

Model No. M2-460

Cat# 45X710

LOW PRESSURE: BLUE - High side pressure from 0 to 500 lbs. Temperature scale for R-134a, R-22, R-404a. 1/8" MPT. 2-1/2" dial face. Full size brass movement. Pointer flutter dampened. Surge dampened. Recalibration screw. High impact Lexan lens.



Price Ea: \$21.50

J/B Refrigeration Manifold Gauges - 2.5"
High Pressure: RED

Model No. M2-465

Cat# 45X720

HIGH PRESSURE: RED - High side pressure from 0 to 500 lbs. Temperature scale for R-134a, R-22, R-404a. 1/8" MPT. 2-1/2" dial face. Full size brass movement. Pointer flutter dampened. Surge dampened. Recalibration screw. High impact Lexan lens.



Price Ea: \$21.50

J/B Refrigeration Manifold Gauges - 2.5"
High Pressure: BLUE

Model No. M2-430

Cat# 45X61

LOW PRESSURE: BLUE - Low Side 30" vacuum to 120 lbs pressure, retard to 350 lbs. Temperature scale for R-134a, R-22, R-404a. 1/8" MPT connection. 2-1/2" dial face. Full size brass movement. Pointer flutter dampened. Surge dampened. Recalibration screw. High impact Lexan lens.



Price Ea: \$21.50

J/B Charging Lines 36" & 60" Long 1/4" Female SAE

1/4' female SAE flare quick couplers. 45 degree elbow on one end with valve core depressor. Reinforced braid engineered for 3,000 PSI burst pressure. Pinpricked outer cover prevents blistering. Special compound for refrigerants and oils.

Model No. CCL-60

Cat# 45X126



Price Ea: \$90.00

Model No. CCL-36

Cat# 45X10



Price Ea: \$69.00

J/B Multi Swaging Tool

6-In-1 Swaging Tool

Multi swage produces perfect solder cups for joining 9 different O.D. tube sizes to another tube of the same size. Unscrew to reveal all sizes.

3/16-1/4-5/16-3/8-7/16-1/2-5/8" OD.

Model No. MA-49318

Cat# 45X49318



Price Ea: \$16.95













<p>Dial Pocket Thermometer - 1" Diameter Head w/ Case Model No. MA-PT160</p>	<p>Digital Stem Thermometer Model No. MA-RT335</p>
<p>This accurate bi-metal thermometer has a 1" diameter head, spiked stem, 5" long and clear black scale on white. Easy to read, will outlast glass thermometer. Hard rubber case with pocket clip. Accurate with 1% of scale range.</p>	<p>Large LCD display. New temperature range -50 degrees F. to +392 degrees F. Anti-rolling head design. Button battery included. Display updates per second. On-Off switch. Fahrenheit / Celsius switchable. With plastic sheath which can also be used as holder and pocket clip.</p>
<p>Model No. MA-PT160 Cat# 0566</p>  <p>Price Ea: \$7.95</p>	<p>Model No. MA-RT335 Cat# 0541</p>  <p>Price Ea: \$18.95</p>
<p>Refrigerator / Freezer Thermometer Model No. MA-RT1</p> <p>Accurate easy to read refrigerator/freezer thermometer. -20 deg F to +80 deg F. Hangs or stands.</p>	<p>Refrigerator / Freezer Thermometer Model No. MA-HRFT1</p> <p>Thermometer as dual scale Fahrenheit and centigrade. -20 deg F to +80 deg F. Hangs or stands.</p>
<p>Model No. MA-RT1 Cat# 05X39</p>  <p>Price Ea: \$7.95</p>	<p>Model No. MA-HRFT1 Cat# 05X40</p>  <p>Price Ea: \$7.95</p>
<p>Remote Reading Vapor Tension Thermometer Model No. MA-60AFF-A</p> <p>All stainless steel case. 2-1/2" dial, 60" capillary. Flush mount with back connect. Dual scale. This thermometer can be calibrated.</p> <p><i>Temperature range: -40 deg F to 60 def F.</i></p>	<p>Vapor Tension Thermometers Model No. MA-60A</p> <p>Replacement for most freezers and cold rooms. 2" dial. With hanger strap, bottom connections. Wall mount, 48" nickel plated capillary. Color coded scales. Recalibration pointer. NSF listed. Range Dual Scale: -40 deg F. to +60 deg F. -40 deg C to 15 deg C.</p>
<p>Model No. MA-60AFF-A Cat# 9019</p> <p>Front Flange Mount</p>  <p>Price Ea: \$39.95</p>	<p>Model No. MA-60A Cat# 9018</p>  <p>Price Ea: \$39.95</p>
<p>ICG-1 Solid State Relay 115V</p>	<p>Solid State Push-On Relay 1/12 HP thru 1/2 HP - 115V</p>
<p>A combination snap or screw on general replacement relay. Will replace ALL CURRENT STARTING RELAYS, from 1/12 thru 1/2 HP. Comes complete with pin type terminals and can also be used on screw type terminals. Can also be used with start capacitor.</p> <p>Model No. ICG-1 Cat# 8029</p>  <p>Price Ea: \$9.95</p>	<p>One size for all compressors 1/12 HP thru 1/2 HP 115 Volt. Replaces ALL Push-On current type relays. For use on compressors with "Pin Type" terminals. Can be used on ALL capacitor and non-capacitor start motors. Lowest resistance solid state relay. Fastest cool down time of all solid state relays. Will restart a balanced system WITHIN ONE MINUTE. Quick and easy install.</p> <p>Model No. PO-115 Cat# 8030</p>  <p>Price Ea: \$9.95</p>

<p>Solid State 3 N' 1 Start Relay Combination Relay, Overload & Capacitor</p> <p>Relay, overload protector and start capacitor. All in one, easy to install package. Completely pre-wired. Replaces all 3 electrical components on all capillary systems. For domestic and commercial refrigerators and freezers. For pin push-on terminals or screw connections.</p> <p>Model No. RCO-810 Cat# 80514</p>  <p>Price Ea: \$17.95</p>	<p>Solid State 3 N' 1 Start Relay Combination Relay, Overload & Capacitor</p> <p>Relay, overload protector and start capacitor. All in one, easy to install package. Completely pre-wired. Replaces all 3 electrical components on all capillary systems. For domestic and commercial refrigerators and freezers. For pin push-on terminals or screw connections.</p> <p>Model No. RCO-410 Cat# 80515</p>  <p>Price Ea: \$17.95</p>	<p>Solid State 3 N' 1 Start Relay Combination Relay, Overload & Capacitor</p> <p>Relay, overload protector and start capacitor. All in one, easy to install package. Completely pre-wired. Replaces all 3 electrical components on all capillary systems. For domestic and commercial refrigerators and freezers. For pin push-on terminals or screw connections.</p> <p>Model No. RCO-210 Cat# 80599</p>  <p>Price Ea: \$19.95</p>
--	---	--

<p>SPP Pow-R-Pak For Low Voltage</p> <p>Simply connect the two wires to the run capacitor as a super assist for all low voltage conditions. Just one model SPP is used for all PSC air conditioning units from 4,000 BTU through 60,000 BTU. For all single phase 115 through 277 Volts. For tight compressors that need an additional boost, use the SPP as a relay with a "Start Capacitor". About 1" in diameter, the SPP packs a real boost. Every air conditioner should have one installed.</p> <p>Cat# 8037</p>  <p>Price Ea: \$13.95</p>	<p>115V Push-On Relay & Overload Combination - Now in One Unit - Combination Relay, Overload & Capacitor</p> <p>Replaces ALL hermetic refrigerator compressor push-on Relay and Overload protectors from 1/12 HP through 1/3 HP 115V. Can be used in conjunction with a start capacitor. Fast, simple installation. Superior overload locked rotor protection. Eliminates start winding overheating.</p> <p>Model No. PRO81 Cat# 80610 1/12 HP - 1/5 HP 115V</p> <p>Model No. PRO41 Cat# 80611 1/4 HP - 1/3 HP 115V</p> <p>Price Ea: \$14.95</p> <p><i>Fast Installation... Just Push it On!</i></p> 	
---	--	--

<p>Paragon Defrost Timer - Time Initiated - Temperature or Pressure Terminated - 120V</p> <p>Frequency of defrost is one to six cycles per day-A minimum of four hours between defrost cycles. Contact arrangements for electric defrost compressor shutdown or hot gas defrost. Switch rating 40 Amp. 120V</p> <p>Model No. 8145-00 Cat# A1814500</p> <p>120V</p>  <p>Price Ea: \$135.00</p>	<p>Klixon Defrost Termination Switches</p> <p>These controls are designed to replace many OEM defrost thermostats. The selection of the proper thermostat can be made by matching the temperature code of the thermostat. Will replace G.E. and Klixon termination switches for domestic refrigerators and freezers.</p> <table border="1" data-bbox="592 1249 1339 1438"> <thead> <tr> <th>CAT#</th> <th>Model No.</th> <th>Klixon No.</th> <th>Temp. Setting</th> <th>Price Ea.</th> </tr> </thead> <tbody> <tr> <td>80605</td> <td>ML45</td> <td>S2064RL45</td> <td>Open 45+ deg F.</td> <td>\$9.95</td> </tr> <tr> <td>80606</td> <td>ML50</td> <td>S2064RL50</td> <td>Open 50+ deg F.</td> <td>\$9.95</td> </tr> <tr> <td>80607</td> <td>ML55</td> <td>S2064RL55</td> <td>Open 55+ deg F.</td> <td>\$9.95</td> </tr> <tr> <td>80608</td> <td>ML60</td> <td>S2064RL60</td> <td>Open 60+ deg F.</td> <td>\$9.95</td> </tr> <tr> <td>80609</td> <td>ML70</td> <td>S2064RL70</td> <td>Open 70+ deg F.</td> <td>\$9.95</td> </tr> </tbody> </table> 					CAT#	Model No.	Klixon No.	Temp. Setting	Price Ea.	80605	ML45	S2064RL45	Open 45+ deg F.	\$9.95	80606	ML50	S2064RL50	Open 50+ deg F.	\$9.95	80607	ML55	S2064RL55	Open 55+ deg F.	\$9.95	80608	ML60	S2064RL60	Open 60+ deg F.	\$9.95	80609	ML70	S2064RL70	Open 70+ deg F.	\$9.95
CAT#	Model No.	Klixon No.	Temp. Setting	Price Ea.																															
80605	ML45	S2064RL45	Open 45+ deg F.	\$9.95																															
80606	ML50	S2064RL50	Open 50+ deg F.	\$9.95																															
80607	ML55	S2064RL55	Open 55+ deg F.	\$9.95																															
80608	ML60	S2064RL60	Open 60+ deg F.	\$9.95																															
80609	ML70	S2064RL70	Open 70+ deg F.	\$9.95																															

<p>Paragon Defrost Timer - Time Initiated - Temperature or Pressure Terminated - 230V</p> <p>Frequency of defrost is one to six cycles per day. A minimum of four hours between defrost cycles. Contact arrangements for electric defrost compressor shutdown or hot gas defrost. Switch rating 40 Amp.</p> <p>Model No. 8145-20 Cat# A1814520</p> <p>230V</p>  <p>Price Ea: \$135.00</p>	<p>Starter POW-R-PAK Combination Relay, & Start Capacitor</p> <p>SUPCO relay and start capacitor combination for hard to start compressors or where low voltage is a problem. Gives additional starting torque to all single phase 115-208-220-230-277 Volt. PSC air conditioning compressors from 4,000 to 90,000 BTU. 1/2 HP to 7-1/2 HP. 2 Wires connect to existing run capacitor for easy installation.</p> <table border="1" data-bbox="592 1669 1502 1984"> <tr> <td data-bbox="592 1669 885 1984"> <p>Model No. SPP5 Cat# 8038</p>  <p>Price Ea: \$14.95</p> </td> <td data-bbox="885 1669 1201 1984"> <p>Model No. SPP6 Cat# 80511</p>  <p>Price Ea: \$23.95</p> </td> <td data-bbox="1201 1669 1502 1984"> <p>Model No. SPP7 Cat# 80544</p>  <p>Price Ea: \$30.95</p> </td> </tr> </table>			<p>Model No. SPP5 Cat# 8038</p>  <p>Price Ea: \$14.95</p>	<p>Model No. SPP6 Cat# 80511</p>  <p>Price Ea: \$23.95</p>	<p>Model No. SPP7 Cat# 80544</p>  <p>Price Ea: \$30.95</p>
<p>Model No. SPP5 Cat# 8038</p>  <p>Price Ea: \$14.95</p>	<p>Model No. SPP6 Cat# 80511</p>  <p>Price Ea: \$23.95</p>	<p>Model No. SPP7 Cat# 80544</p>  <p>Price Ea: \$30.95</p>				

Oval Motor Run Capacitors Single Section - 370V					
UL Listed 370V. CSA Approved. Single section 50/60 HZ					
CAT#	MFD	Width	Depth	Height	Price Ea.
POC5	5	1/1/4"	2"	1-1/2"	\$4.50
POC7.5	7.5	1-5/16"	2-5/32"	2-3/8"	\$4.95
POC10	10	1-5/16"	2-5/32"	2-5/8"	\$5.50
POC12.5	12.5	1-5/16"	2-5/32"	3"	\$6.95
POC15	15	1-5/16"	2-5/32"	3-3/4"	\$7.50
POC20	20	1-29/32"	2-29/32"	2-5/8"	\$8.50
POC25	25	1-29/32"	2-29/32"	2-5/8"	\$8.95
POC30	30	1-29/32"	2-29/32"	3"	\$10.50
POC35	35	1-29/32"	2-29/32"	3-3/4"	\$11.50
POC40	40	1-29/32"	2-29/32"	3-3/4"	\$13.50
POC45	45	1-29/32"	2-29/32"	3-3/4"	\$14.95
POC50	50	1-29/32"	2-29/32"	4-3/4"	\$15.95
POC55	55	1-29/32"	2-29/32"	4-3/4"	\$16.95
POC60	60	1-29/32"	2-29/32"	4-3/4"	\$17.95
POC80	80	1-29/32"	2-29/32"	4-3/4"	\$23.95



Motor Start Capacitors - Plastic Case 110/125 Dual Volts AC 60 HZ			
110/125 Dual Volts AC 50/60 HZ			
CAT#	Microfard - +	Diameter & Length	Price Ea.
12001	88-108	1-7/16" x 2-3/4"	\$7.95
12002	108-130	1-7/16" x 2-3/4"	\$7.95
12003	124-149	1-7/16" x 2-3/4"	\$8.50
12004	145-175	1-7/16" x 2-3/4"	\$8.75
12005	161-193	1-7/16" x 2-3/4"	\$8.95
12006	189-227	1-7/16" x 3-3/8"	\$9.50
12008	216-259	1-7/16" x 3-3/8"	\$9.50
12009	233-280	1-7/16" x 3-3/8"	\$9.95
12010	270-324	1-7/16" x 3-3/8"	\$9.95
12012	324-389	1-13/16" x 3-3/8"	\$11.95
12014	378-454	1-13/16" x 3-3/8"	\$11.95
12015	400-480	1-13/16" x 3-3/8"	\$13.95
12016	460-552	2-13/16" x 4-3/8"	\$13.95

Elco 5 Watt CW Condensor Fan Motors

MDL# N5-13222 - 220V

1,400 RPM. Hubless type fan motor. 2-screw bottom mount. CW air over motor. 0.20 amp. 220V.

Model No. N5-13222

Cat# A1MN51

Price Ea: \$19.95

250/220 Dual Volts AC 60 HZ			
CAT#	Microfard - +	Diameter & Length	Price Ea.
12001	88-108	1-7/16" x 2-3/4"	\$7.95
12002	108-130	1-7/16" x 2-3/4"	\$7.95
12003	124-149	1-7/16" x 2-3/4"	\$8.50
12004	145-175	1-7/16" x 2-3/4"	\$8.75
12005	161-193	1-7/16" x 2-3/4"	\$8.95
12006	189-227	1-7/16" x 3-3/8"	\$9.50
12008	216-259	1-7/16" x 3-3/8"	\$9.50
12009	233-280	1-7/16" x 3-3/8"	\$9.95
12010	270-324	1-7/16" x 3-3/8"	\$9.95
12012	324-389	1-13/16" x 3-3/8"	\$11.95
12014	378-454	1-13/16" x 3-3/8"	\$11.95
12015	400-480	1-13/16" x 3-3/8"	\$13.95
12016	460-552	2-13/16" x 4-3/8"	\$13.95

ECONOMASTER Direct Drive Blower Motors

48 Frame

Permanent Split Capacitor. Three Speed. 48 Frame. Electrically reversible. Sleeve and ball bearing. Automatic overload. 2-1/2" Diameter mounting rings. Belly band or Ring mount. No run capacitor included.

CAT#	H.P.	RPM	Volts	Price
EM3585	1/3	1075/3	115	\$114.00
EM3587	1/2	1075/3	115	\$138.00
EM3589	3/4	1075/3	115	\$145.00

330 Volts AC 60 HZ			
CAT#	Microfard - +	Diameter & Length	Price Ea.
12027	88-108	2-1/16" x 4-3/8"	\$12.95
12028	108-130	2-9/16" x 4-3/8"	\$13.95
12029	130-156	2-9/16" x 4-3/8"	\$14.95
12030	145-175	2-1/16" x 4-3/8"	15.95
12031	161-193	2-9/16" x 4-3/8"	16.95
12032	189-227	2-9/16" x 4-3/8"	18.95

Professional Heavy Duty Flaring Tool 45 Degree SAE

Bar type heavy duty forged steel yoke slips over flaring bar and locks with turn. Flare sizes: 3/16", 1/4", 5/16", 3/8", 7/16", 1/2", 5/8" OD

Model No. T20195

Cat# 45X2

Price Ea: \$85.50

Frigid-Air Domestic Evaporator Fan Motor

115V / 60HZ

Replacement evaporator motor for: Admiral-Amana-Coldspot-Frigidaire-General Electric-Hot Point-Westinghouse-Norge-Whirlpool. Heavy duty fan motor, oversized oil reservoir.

Cat# A1M1733

Volts: 115V
Shaft Dia: 1/8"
Shaft Length: 1-1/4"

Price Ea: \$9.95

Replacement MARS II Potential Motor Starting Relays 3ARR3 Type Relays

3ARR3 Type relays will interchange thousands of relay variations. Six relays replaces thousands of OEM models. Universal mounting bracket, with push-on terminals. Mounts in any position, adaptable to a wide variety of mounting brackets. Lets you handle replacements with a minimum of stock.

CAT#	Individual Relays	Replaces 3ARR3 Relay Groups	Price Ea.
52163	Mars II 63	2J:2K:2L:2M:5N:7J:7L:7M:8L:8M:8N:	\$42.00 Ea.
52164	Mars II 64	3A:3B:3AV:3AU:4A:4B:6A:6B:6AV:10A:10B:10AU:10AV	
52165	Mars II 65	3P:3R:5R:5S:5T:22S	
52166	Mars II 66	3U:3V:3AT:6U:6V:6W:6TV:6TW:10V	
52167	Mars II 67	3C:3D:3AA:4C:4D:4BK:6C:6D:6AA:10C:10D:26D	
52168	Mars II 68	3E:3F:3AB:3AC:4E:4F:4G:6E:6F:6G:10H:10AB:10AC	
Optional Mars Relays.			
52169	Mars II 69	3S:3T:10S:10T:25S:25T:10AS	\$42.00 Ea.
52170	Mars II 70	5B:5C:5D:5AA:8B:8C:8D	



25 to 60 Amp Compact Design Contactors

The latest generation of GTE contactors includes one of the smallest 50 to 60 amp contactors available in the industry. The 40 Amp and larger models feature large box-lug terminals for fast and easy wiring. Features of these compact contactors are: Small dimension make replacement easy. Used in refrigeration, air conditioning and resistance heating. Line and coil terminals feature combination quick-connect and screw or box-lug connections. Universal mounting base. UL & CSA approved.

CAT#	Part No.	FLA	Amps	Coil Volts	No. of Poles	Price Ea.
1015	30AS-3P-24	30	40	24	3	\$22.00
1017	30AS-3P-230	30	40	230	3	\$22.00
1018	40AS-3P-24	40	50	24	3	\$28.00
1020	40AS-3P-230	40	50	230	3	\$28.00
1021	50AG-3P-24	50	62	24	3	\$48.00
1023	50AG-3P-230	50	62	230	3	\$48.00
1024	60AG-3P-24	60	75	24	3	\$59.00
1026	60AG-3P-230	60	75	230	3	\$59.00
1029	30AS-2P-24	30	40	24	2	\$19.00
1030	30AS-2P-230	30	40	230	2	\$19.00
1031	40AS-2P-24	40	50	24	2	\$20.00
1032	40AS-2P-230	40	50	230	2	\$20.00



Full Gauge Controls - TC-900 & MT-512 Controllers for Walk in Freezers and Display Freezers.

For cooling and defrosting, works with two sensors, one being for ambient temperature and the other fixed to the evaporator that controls defrost ending. With the powerful 16-amp relay it directly controls compressors up to 1 HP and uses a switch mode power supply (universal input range from 90 to 264 VAC.) The defrost output has a 10A current capacity, as well as having Normally Closed (NC) contact available. It also has indicators in C and F and digital filter, which have the purpose of simulating an increase of mass in the environment sensor (S1), thus increasing its response time and preventing unnecessary activation of the compressor.

Featuring an off cycle defrost function, by means of compressor shutdown, and permanent ventilation, it presents one command output and an integrated cyclic timer to set cooling and defrosting cycle. It also features an intelligent system to lock the keys and deactivate the control functions, besides a digital filter aimed at simulating an increase of mass in the environment sensor (S1) thus increasing its response time preventing unnecessary activation of the compressor. Available in 16 amp version for direct operation of compressors up to 1 HP.

TC-900 Power for Walk-In and Display Freezers

MT-512 For Walk-In and Display Coolers

Model No. TC-900

Model No. MT-512

Cat# 6061

Cat# 6062



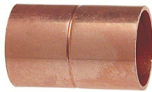

Price Ea: \$139.00

Price Ea: \$119.00

Mueller Wrot Copper Solder Refrigeration Fittings - O.D. Couplings			
CAT#	Mfg.#	O.D. Size	
18X1	W01001	3/16"	 <p>Call For Prices</p>
18X2	W01003	1/4"	
18X3	W01042	5/16"	
18X4	W01009	3/8"	
18X5	W01017	1/2"	
18X6	W01022	5/8"	
18X7	W01028	3/4"	
18X8	W01034	7/8"	
18X9	W01047	1-1/8"	

Mueller Reducing O.D. Couplings			
CAT#	Mfg.#	O.D. Size	
18X20	W01004	1/4" x 3/16"	 <p>Call For Prices</p>
18X22	W01011	3/8" x 1/4"	
18X23	W01019	1/2" x 3/8"	
18X24	W01023	5/8" x 1/2"	
18X25	W01029	3/4" x 5/8"	
18X26	W01035	7/8" x 3/4"	

90 Degree O.D. Elbows			
CAT#	Mfg.#	O.D. Size	
18X30	W02003	1/4"	 <p>Call For Prices</p>
18X32	W02009	3/8"	
18X33	W02017	1/2"	
18X34	W02022	5/8"	
18X35	W02028	3/4"	
18X36	W02034	7/8"	
18X37	W02047	1-1/8"	

Mueller O.D. Tees			
CAT#	Mfg.#	O.D. Size	
18X46	W40302	3/16"	 <p>Call For Prices</p>
18X47	W40306	1/4"	
18X48	W40313	5/16"	
18X49	W04000	3/8"	
18X50	W04001	1/2"	
18X51	W04006	5/8"	
18X52	W04017	3/4"	
18X53	W04031	7/8"	

JB Refrigeration SAE Brass Fittings - Short Forged Brass Flare Nuts			
CAT#	Mfg.#	SAE Flare	
4502	NS4-4	1/4"	 <p>Call For Prices</p>
4504	NS4-6	3/8"	
4505	NS4-8	1/2"	
4506	NS4-10	5/8"	

Brass SAE Flare Union			
CAT#	O.D. Size		
4513	1/4"	 <p>Call For Prices</p>	
4515	3/8"		
4516	1/2"		
4517	5/8"		

Mueller Suction Line P-Traps			
CAT#	Mfg.#	O.D. Size	
18X80	W60099	5/8"	 <p>Call For Prices</p>
18X81	W61008	3/4"	
18X82	W61000	7/8"	
18X83	W61001	1-1/8"	
18X84	W61002	1-3/8"	
18X85	W61003	1-5/8"	
18X86	W61009	2-1/8"	

Refrigeration ROTO-LOCK Service Valves			
CAT#	Tube Connection Size	Price Ea.	
A1V38	3/8" SAE	\$28.95	
A1V12	1/2" SAE	\$39.95	
A1V58	5/8" SAE	\$45.95	
A1V78	7/8" OD	\$69.95	
A1V18	1-1/8" OD	\$79.95	

Brass Half Union SAE Flare x Male Pipe Thread			
CAT#	Mfg.#	SAE x IPT	
4523		1/4" x 1/8"	 <p>Call For Prices \$</p>
4524		1/4" x 1/4"	
4525		1/4" x 3/8"	
4527		3/8" x 1/4"	
4528		3/8" x 3/8"	
4529		3/8" x 1/2"	
4531		1/2" x 3/8"	
4532		1/2" x 1/2"	

Bronz Vibration Eliminators - Copper Ends

Copper braid covered hose eliminates the vibration between the refrigeration unit and the line tubing. Prevents copper line breakage in refrigeration and air conditioning systems. Underwriters listed.

CAT#	O.D. Size	Long	
40105	1/4"	7-1/2"	 <p>Call For Prices</p>
40106	3/8"	8-1/4"	
40107	1/2"	9"	
40108	5/8"	9-3/4"	
40109	3/4"	11-1/4"	
40110	7/8"	11-1/2"	
40111	1-1/8"	13"	
40112	1-3/8"	14-3/4"	

MA-Line Nylon Sand Screen - Open Mesh

Sand screen is superior to sand cloth for cleaning copper surfaces prior to brazing or soldering. An open nylon screen like material with abrasive on both sides. Won't break down or clog up like paper or cloth type materials.

Model No. MA-90502
 Cat# 05101 - 1-1/2" x 5 Yards



Price Ea: \$7.50

Solid State Time Delays

Input 18-240 VAC. 10 Minute adjustable max load. 1.5 amps.

Cat# 05102 Delay on Make
 Cat# 05203 Delay on Break

Price Ea: \$10.95



Leak Lock - Refrigeration Joint Sealer

The pipe joint sealing compound especially developed for refrigeration applications. Makes a positive seal on fittings, gaskets, etc. that will not leak. Permanently insoluble, never hardens, stays plastic smooth and free of pin holes. Can't dry out or crack. A little goes a long way.

Cat# 3900 - 1-1/3 oz. Tube

Price Ea: \$5.95

Cat# 3901 - 4 oz. Brush-cap

Price Ea: \$14.95



Trace Refrigerant Leak Detector

HOW IT WORKS. Trace locates refrigerant and oil leaks by leaving a bright red color at the location of the leak. It circulates through the system with the refrigerant and oil and is forced out with the escaping gas at the leak.

For Mineral Oil

Cat# 3907 - 4 oz. Bottle

Price Ea: \$12.50

Cat# 3908 - Pint Bottle

Price Ea: \$25.95

For Polyester Oil

Cat# 3999 - 4 oz. Bottle

Price Ea: \$13.50



SUPCO 88 Oil

SUPCO is added to the oil in compressors to prevent acid and sludge forming on bearing surfaces. It helps reduce friction on all moving parts, prevent rusting and corrosion and increases the efficiency of the unit.

Model No. S-8

Cat# 8127

Price Ea: \$8.95



Thawzone- Liquid Drier for Refrigeration Systems

New formula all liquid Thawzone. Added to the refrigerant it circulates through the system. Chemically dries all fluorinated refrigerants, R-12, R-22, R-502, etc. Works when solid driers fail. Prevents corrosion, neutralizes acids and reduces sludge.

Cat# 3904 - 1 oz. Bottle

Price Ea: \$5.95

Cat# 3908 - 4 oz. Bottle

Price Ea: \$14.95



Electrical All Weather Plastic Tape

Plastic electrical tape, Poly Vinyl Chloride retains its stretch conformity through a wide range of temperature and humidity. 0 deg. F. to 176 deg. F. 3/4" Wide x 66" Long.

Model No. MA-C6408

Cat# A1402

Price Ea: \$2.95



High-Side A/C Leak Repair Kit

For AC and Refrigeration. All in one quick sealing leak stop, lubricator, conditioner, with UV dye to locate larger leaks.

Model No.

Cat# 39R3

Price Ea: \$69.00



Refrigerant Gas Leak Detector

Revolutionary foam refrigerant and gas leak detector. Works on the soap bubble principle but is applied as a thick creamy foam that can be spread conveniently and will not run off. Ideal for use on cold lines. Special formula will not freeze. Unbreakable plastic bottle.

Model No. 22008

Cat# 80512

Price Ea: \$7.95

8 oz. Bottle



Super Turbine Oil - for High Speed Shafts and Bearings

Oils everything that needs to be oiled. A real problem solver for the appliance service man. Use on electric motor bearings, withstands high temperature. A must for heater blowers. Frees sticky and stuck bearings, keeps bearing surfaces clean, contains SUPCO 88, with pull-out spout for hard to reach equipment.

Model No. MO98

Cat# 80001

8 oz. Bottle

Price Ea: \$4.50



SUPCO - Bullet 3-In-1 Piercing Valve

Install on the High Side as a PERMANENT VALVE on the job. The BULLET Piercing Valve will not leak and can not be budged with a Stillson wrench. The only multi-size valve with a permanent gasket. Only 2 inch clearance is required for installation and operation. One size for 1/4", 5/16", 3/8" inch tubing. Installs on round or uneven tubing. Sizes: 1/4", 5/16", 3/8".

Sizes: 1/2" & 5/8"

Model No. BPV-31

Cat# 8024

Price Ea: \$4.95



Model No. BPV-21

Cat# 8025

Price Ea: \$5.95

1/4" SAE Refrigeration Access Valves w/ Quick Seal Caps

CAT#	Mfg.#	O.D. Size	Price Ea.
4571	A31002	1/8"	\$2.50
4572	A31003	3/16"	\$2.50
4573	A31004	1/4"	\$2.50
4574	A31005	5/16"	\$2.95
4575	A31006	3/8"	\$2.95
4576	A31008	1/2"	\$4.50



C & D "M" Series Saddle Type Copper to Copper Line Tap Valves 1/4" SAE Access

CAT#	Mfg.#	O.D. Size	Price Ea.
3330	CD5514	1/4"	\$4.95
3331	CD5516	5/16"	\$4.95
3332	CD5538	3/8"	\$5.50
3333	CD5512	1/2"	\$5.50
3334	CD5558	5/8"	\$5.95
3335	CD5578	7/8"	\$6.50



RSS Universal Air Switch

Universal Air switch. Range: .2 WC - 1.0 WC
Senses: Positive & Negative Pressure
N-O and N-C Micro Switch.

Model No. RSS-495-011

Cat# 80495

Price Ea: \$29.95



J/B Heavy Duty Tube Cutter

Tube cutter 1/8" to 1-1/8" OD.

Model No. RT70020

Cat# 45T12

Price Ea: \$45.75



Professional Heavy Duty Flaring Tool 45 Degree SAE

Bar type heavy duty forged steel yoke slips
over flaring bar and locks with turn.

Flare sizes: 3/16", 1/4", 5/16", 3/8",
7/16", 1/2", 5/8" OD

Model No. T20195

Cat# 45X2

Price Ea: \$85.50



J/B Mini Tube Cutter

Mini Tube cutter. Designed for service work in cramped spaces. Nickel chrome
plated. 1/8" - 7/8" OD.

Model No. RT70015

Cat# 45T20

Price Ea: \$33.95



SUPCO Fin Jack

Supco Fin Jacks. Straightens and separates bent fins.

Model No. FPT10 9 & 10 fins per inch

Cat# 8122

Model No. FPT10 11, 12 & 13 fins per inch

Cat# 8123

Model No. FPT10 14, 15 & 16 fins per inch

Cat# 8123

Price Ea: \$21.95



SUPCO Multi-Fit Replacement Evaporator Motor

Replaces any OEM Evaporator Motor. 115V 50/50 HZ. Shaft: 1/8"
Diameter with adaptors for 3/16" and hubless fans. 1 Speed: 3,000 RPM CW or
CCW rotation. Overload-Impedance protected. Stock one motor-save on inven-
tory. Break-Off shaft. Mounting accessories and hardware included.

Model No. SM999 Multi-Fit With Accessories

Cat# 0200

Price Ea: \$26.95

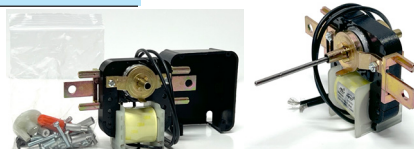

CERRO Copper Tubing

Refrigeration soft copper tubing for installation and maintenance of refrigeration
and air conditioning equipment. Fine copper tubing dehydrated and sealed,
properly, annealed to the right temper for easy flaring. When you buy CERRO
copper tube you are buying American made tube of the finest quality.
SOLD ONLY IN 50 FT INDIVIDULLY BOXED COILS.

CAT#	Wall Thick	O.D. Size
2402	.030	1/4"
2403	.032	5/16"
2404	.032	3/8"
2405	.032	1/2"
2406	.035	5/8"
2407	.035	3/4"
2408	.045	7/8"



\$ Call For Prices \$

Parker Thermostatic Expansion



CAT#	Refrg.	Normal Ton Range	Equalizer Type	Inlet Con.	Outlet SAE	Model	Temp	Cost
7570	R-134A	1/4-3/4	Internal	1/4"	1/2"	N-1 2-JW	Medium	\$145.00
7571	R-134A	1/2-1	Internal	3/8"	1/2"	N-1-JW	Medium	\$145.00
7572	R-404A	1/4-3/4	Internal	1/4"	1/2"	N-1 2-SW	Medium	\$145.00
7573	R-404A	1/4-3/4	Internal	3/8"	1/2"	N-1 2-SZ	Low	\$145.00
7574	R-134A	1/2-1	Internal	3/8"	1/2"	C-A-JW	Medium	\$175.00
7575	R-134A	1-2	Internal	3/8"	1/2"	C-B-JW	Medium	\$175.00
7576	R-134A	1-2	External	3/8"	1/2"	CE-B-JW	Medium	\$175.00
7577	R-134A	2-3	External	3/8"	1/2"	CE-C-JW	Medium	\$175.00
7578	R-404A	1/2-1	Internal	3/8"	1/2"	C-A-SW	Medium	\$175.00
7579	R-404A	1/2-1	Internal	3/8"	1/2"	C-A-SZ	Low	\$175.00
7580	R-404A	1-2	External	3/8"	1/2"	CE-B-SW	Medium	\$175.00
7581	R-404A	1-2	External	3/8"	1/2"	CE-B-SZ	Low	\$175.00
7582	R-404A	2-3-1/2	External	3/8"	1/2"	CE-C-SW	Medium	\$175.00
7583	R-404A	2-3-1/2	External	3/8"	1/2"	CE-C-SZ	Low	\$175.00

Flare to Sweat Adaptors



1/4" FL Nut to 1/4" OD

Cat# 4580

Price Ea: \$5.50



3/8" FL Nut to 3/8" OD

Cat# 4581

Price Ea: \$6.50



1/2" FL Nut to 1/2" OD

Cat# 4581

Price Ea: \$6.95

White-Rodgers Commercial Temperature Control

White-Rodgers commercial temperature control
easily adjusted with screw driver. Hydraulic
action element provides close differential
control, positive accuracy at any temperature
on dial range. All position mounting. Range 30
deg. F to 40 deg. F. With adjustable differential
3 deg. F. to 40 deg. F. 5 ft capillary tube, sensor
bulb size 3/8" x 5-3/4" long.



Model No. 1609-101

Cat# A1T975

Price Ea: \$89.00

Hubless Type - 7,8,9 & 10" Aluminum Fan Blades

for G.E. Condenser Fan Motors

CAT#	Diameter	Price Ea.
CW Rotation		
3706-31	7"	\$9.00
3806	8"	\$9.00
3906-31	9"	\$9.50
3106-31	10"	\$11.00
CCW Rotation		
3706-1	7"	\$9.00
3706-2	8"	\$9.00
3706-3	9"	\$9.50
3706-4	10"	\$11.00



Hub Type - Aluminum Fan Blades

for G.E. Condenser Fan Motors

Designed for walk in cooler evaporators. These fan blades can be used on Bohn, Singer, Hill and other popular brand evaporators.



CAT#	Diameter	Rotation	Bore	Price Ea.
35504	5-1/2"	CW	1/4"	\$8.95
35514	5-1/2"	CCW	1/4"	\$8.95
30604	6"	CW	1/4"	\$8.95
30614	6"	CCW	1/4"	\$8.95
30704	7"	CW	1/4"	\$8.95
30714	7"	CCW	1/4"	\$8.95
30804	8"	CW	1/4"	\$9.95
30814	8"	CCW	1/4"	\$9.95
30805	8"	CW	5/16"	\$9.95
30815	8"	CCW	5/16"	\$9.95
31005	10"	CW	5/16"	\$11.95
31015	10"	CCW	5/16"	\$11.95
31205	12"	CW	5/16"	\$16.95
31215	12"	CCW	5/16"	\$16.95

Acme-Miami - Plastic Fan Blades

for G.E. Condenser Fan Motors

Acme-Miami plastic fan blades are made of heat-resistant celcon for truer balance smoother running no distortion. Each blade packaged in see through

CAT#	Mfg. No.	Diameter	Rotation	Bore	Price Ea.
0607	2303	3-1/2"	CW-White	3/16"	\$4.95
0608	2313	3-1/2"	CCW-Gray	3/16"	\$4.95
0645	2402	4"	CW	1/8"	\$5.95
0644	2412	4"	CCW	1/8"	\$5.95
0609	2402	4"	CW	3/16"	\$5.95
0610	2413	4"	CCW	3/16"	\$5.95

Harris Dyna Flow Solder 6% Silver

With silver prices soaring, **DYNAFLOW** is the answer to all copper to copper joining applications. **DYNAFLOW'S** perfect balance of phosphorus and silver produces properties so similar to a 15% silver alloy, the only difference you will notice is the price. 1/8" x .050 x 20".

Cat# 3615 1 lb 28 pcs.

Cat# 3616 1/4 lb 7 pcs.



Call for Prices

Stay-Sliv Silver Brazing Flux

For use with high temperature silver solder. Joins all dissimilar metals other than aluminum. 7 oz. Brush-Top jar.

Cat# 3608 7 oz Brush-Top Jar



Price Ea: \$8.95

Stay-Clean Soft Solder Flux

For all solder melting under 700 deg. F. except aluminum.

Cat# 3610 4 oz. Flip-Spout Cap

Price Ea: \$7.95

Cat# 3611 16 oz. Bottle

Price Ea: \$11.95



WhirlPool Accessories - Surface Burner Knob Kit

WhirlPool Accessories - Surface Burner Knob Kit.

Cat# 4803



Price Ea: \$7.95

Digital Stem Thermometer Model No. MA-RT335

Large LCD display. New temperature range -50 degrees F. to +392 degrees F. Anti-rolling head design. Button battery included. Display updates per second. On-Off switch. Fahrenheit / Celsius switchable. With plastic sheath which can also be used as holder and pocket clip.

Model No. MA-RT335

Cat# 0541



Price Ea: \$18.95

LA-CO Heat Seal Stick

LA-CO Heat Seal Stick has been acclaimed to be a fast easy fool-proof way to repair leaks, punctures and knife wounds in refrigerator evaporators and tubing. Heat part to 400 deg. F. apply LA-CO Heat Seal Stick and job is done. Sets in 30 seconds, withstands 250 lbs. of pressure at 350 deg. F.

Cat# 4803



Price Ea: \$19.95

<p>Lucas Milhaupt-Silvaloy 450 Silver Brazing</p> <p>The most widely used alloy in the industry. Has lowest working temperature and excellent flow properties. Forms highly ductile joints on similar or dissimilar metals.</p> <p>Cat# 3600 1 Troy Oz.</p> <p>Melting range: 1125 deg. F. to 1145 deg.F. Wire diameter: 1/16" x 66" long.</p>  <p>Call For Prices</p>	<p>Lucas Milhaupt-Silvaloy 452 Silver Brazing</p> <p>The most widely used alloy in the industry. Has lowest working temperature and excellent flow properties. Forms highly ductile joints on similar or dissimilar metals. Flux coated. 45% Ag. 8 Rods.</p> <p>Model# 98100</p> <p>Solidus: 1195 deg.F. Liquidus: 1251 deg. F.</p>  <p>Call For Prices</p>
<p>Lucas Milhaupt-Sli-Fos 15% Silver Brazing</p> <p>For general brazing of copper to brass where higher ductility is required. 1/8" x .050 x 20".</p> <p>Cat# 3601 1/4 lb. 7 pcs. Cat# 3602 1 lb. 28 pcs.</p>  <p>Call For Prices</p>	<p>Lucas Milhaupt AL 822</p> <p>The most widely used alloy in the industry. Has lowest working temperature and excellent flow properties. Forms highly ductile joints on similar or dissimilar metals. Aluminum Braze. Flux cored. 45% Ag. 4 Rods. .090" Dia.</p> <p>Model# 99088</p> <p>Solidus: 800 deg.F. Liquidus: 900 deg. F.</p>  <p>Call For Prices</p>
<p>MA-LINE Digital Clamp Meter</p> <p>Digital Clamp-On Meter with Temperature Measuring Feature. Large Digital Display. AC Current to 600 A - DC Volts to 600 V - AC Volts to 600 V. Ohms (resistance). Audible Continuity. Temp Range -38to 1750 F. Data Hold Feature. Peak Data Hold Feature.</p> <p>Cat# MA-600CFA</p>  <p>\$69.00 Ea.</p>	<p>MA-LINE Flame Shield</p> <p>MA-Line Deluxe Flame Shield. Size: 12" x 12" (300 mm x 300mm). Heat-Resistant woven glass fabric mat. Protects surrounding areas when soldering and brazing. Resists temperatures up to 2000 deg. F.</p> <p>Model# MA-62300</p>  <p>\$21.00 Ea.</p>
<p>MA - 7" Locking Pinch-Off Tool</p> <p>For general brazing of copper to brass where higher ductility is required. 1/8" x .050 x 20".</p> <p>Cat# MA-1RRA</p>  <p>\$16.00 Ea.</p>	<p>MA-Line Hub & Fan Blade Puller Tool</p> <p>Easily removes blades and wheels without damage. Two pullers in one. Save time and money!</p> <p>Model# MA-FB2</p>  <p>\$32.00 Ea.</p>

1/3 HP

COMMERCIAL TEMPERATURE AIR-COOLED CONDENSING UNIT

High starting torque. Air cooled condensing unit for expansion valve or capillary tube application. Unit complete with liquid receiver tank, high side and low side service valves and all electrical starting components.

* Remove receiver tank for capillary tube application.

FOR CAPILLARY TUBE APPLICATION



\$450.00 Ea.

Cat# A1C938 1/3 HP - R-404A / R-22 POE

Cat# A1C933 1/3 HP - R-404A / R-22 Poly-Ester Oil

1/4 HP

COMMERCIAL TEMPERATURE AIR-COOLED CONDENSING UNIT

High starting torque. Air cooled condensing unit for expansion valve or capillary tube application. Unit complete with liquid receiver tank, high side and low side service valves and all electrical starting components.

* Remove receiver tank for capillary tube application.

HIGH TORQUE FOR EXPANSION VALVE OR CAPILLARY TUBE APPLICATION



\$495.00 Ea.

Cat# A1C938 1/3 HP - R-404A / R-22 POE

Cat# A1C933 1/3 HP - R-404A / R-22 Poly-Ester Oil

Unit Bearing Condenser Motors

Morill 6W CW 2309/1/60 Motor

1,500 RPM. 1/4" threaded shaft. 3 Hole back mount or 4 hole top and bottom mount. For up to 9" hubless fan blade.

Cat.# F3255

\$12.95 Ea.

Morill 6W CW 2309/1/60 Motor.

1,500 RPM. Cast Iron Body. 1/4" threaded shaft. 3 Hole back mount or 4 hole top and bottom mount. For up to 10" hubless fan blade.

Cat.# F5416W

\$25.00 Ea.

COLDPARTS, INC.

4401 S. WESTERN BLVD.
CHICAGO, IL 60609

Domestic and Export Wholesale Distributors
of Refrigeration - Air Conditioning - Heating -
Motors - Parts & Supplies

PRST STD
U.S. POSTAGE
PAID
CHICAGO, IL
PERMIT NO. 4784

DANFOSS-SECOP COMPRESSOR MDL# BD80F	EMBRACO COMPRESSOR MDL# NE6210Z	DANFOSS REFRIGERATION COMPRESSOR MDL# GUY60NR
DC INVERTER 12-24V.	Medium Temperature. HST For TXV or capillary tube, comes with electrical and POE oil.	Medium Temperature. HST For TXV or capillary tube, comes with electrical and POE oil.
Model No. BD80F CAT.# A1CBD80 HP: 1/4 Volts: 115V Refrigerant: R-134A Mount: 4" x 6.5"  Price Ea: \$110.00	Model No. NE6210Z CAT.# A1C6210Z2 HP: 1/3 Volts: 230V Refrigerant: R-134A Mount: 4" x 6.5"  Price Ea: \$200.00	Model No. GUY60NR CAT.# A1CY60NR HP: 1/5 Volts: 115-127V Refrigerant: R-134A Mount: 4" x 6.5"  Price Ea: \$125.00
DANFOSS-SECOP COMPRESSOR MDL# FR6G	DANFOSS-SECOP COMPRESSOR MDL# FR8.5G	DANFOSS-SECOP COMPRESSOR MDL# SC12G
LBP 650 BTU @-10F. Low temperature. For capillary tube with electrical and POE oil.	LBP-800 BTU / HBP-3,000 BTU. HST for TXV or capillary tube with electrical and POE oil.	LBP-921 BTU / HBP-3,400 BTU. HST For capillary tube or TXV, comes with electrical and POE oil.
Model No. FR6G CAT.# A1CFR6230 HP: 1/5 Volts: 230V Refrigerant: R-134A Mount: 4" x 6.5"  Price Ea: \$79.00	Model No: FR8.5G CAT.# A1CFR85230 HP: 1/4 Volts: 230V Refrigerant: R-134A Mount: 4" x 6.5"  Price Ea: \$99.00	Model No. SC12G CAT.# A1CTSC12G230 HP: 1/3 Volts: 230V Refrigerant: R-134A Mount: 4" x 6.5"  Price Ea: \$175.00
DANFOSS-SECOP COMPRESSOR MDL# TL2.55	DANFOSS-SECOP COMPRESSOR MDL# TL3G	SANYO REFRIGERATION COMPRESSOR MDL# C-Q50M2C - R-12
L-MBP Low torque for capillary tube. Comes with electrical and POE oil.	L-MBP Low torque for capillary tube. Comes with electrical and POE oil.	170 BTU @-10 F. Low Temp. Comes with overload, relay and oil charge. No terminal cover.
Model No. TL2.55 CAT.# A1CTL26230 HP: 1/12 Volts: 230V Refrigerant: R-134A Mount: 4" x 6.5"  Price Ea: \$85.00	Model No. TL3G CAT.# A1CTL32230 HP: 1/10 Volts: 230V Refrigerant: R-134A Mount: 4" x 6.5"  Price Ea: \$85.00	Model No. C-Q50M2C CAT.# HP: 1/16 Volts: 115V Refrigerant: R-12 Mount: 4" X 6.5"  Price Ea: \$ 45.00
ASPERA COMPRESSOR MDL# NB6152E	TECUMSEH COMPRESSOR MDL# AKA9427ZXA	COPELAND 1/3 HP Compressor 115V / 1PH / 60HZ - R-404A
2,500 BTU @ 45+F. HST. Medium temperature. With relay, overload, start cap, cover and oil charge.	2,700 BTU @ 20+F. HST. Medium temperature. With relay, overload, start cap, cover and mineral	2,400 BTU @ 20+F. L-MBP. HST for TXV or capillary tube with electrical and POE oil.
Model No. NB6152E CAT.# A1C6152E HP: 1/5 Volts: 115V Refrigerant: R-404A Mount: 4" x 6.5" / 8" H  Price Ea: \$125.00	Model: AKA9427ZXA CAT.# F549427 HP: +1/3 Volts: 115V Refrigerant: R-404A/R-22 Mount: 4.8" x 8"  Price Ea: \$250.00	Model No. ASE24C5E-IAA CAT.# A1C24C5E HP: 1/3 Volts: 115V Refrigerant: R-404A Mount: 4" x 6.5"  Price Ea: \$185.00

COLDPARTS, INC.
4401 S. WESTERN BLVD.
CHICAGO, IL 60609

PH: 773-247-8842 800-445-1281

www.coldparts.com

e-mail: info@coldparts.com